

GROUND FLOOR

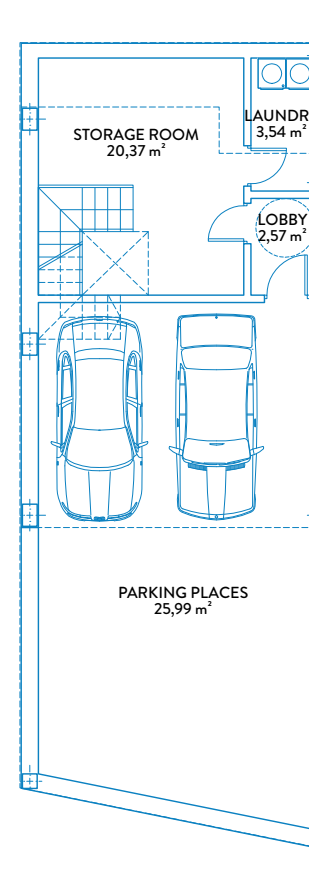

BASEMENT



BUILT AREAS

Townhouse area	144,89 m ²
Basement area	59,40 m ²
Solarium area	46,35 m ²
Terrace area	51,18 m ²
Garden area	205,08 m ²

USEFUL AREAS

Townhouse area	112,81 m ²
Basement area	52,47 m ²

BOJA AREAS

Useful area	124,09 m ²
Built area	159,38 m ²

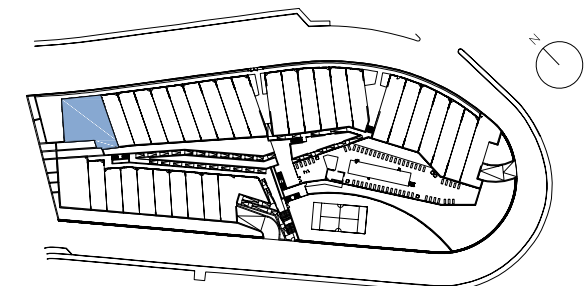

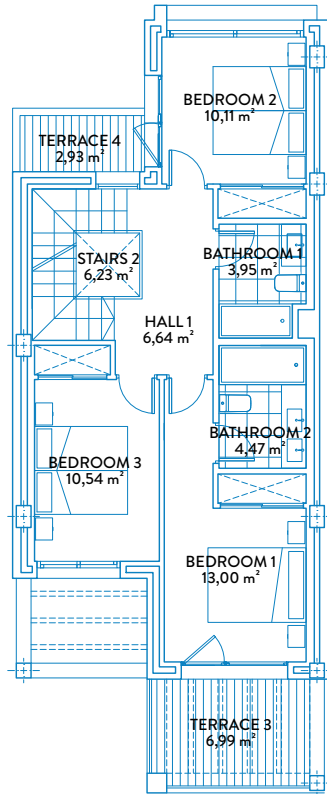

FIRST FLOOR

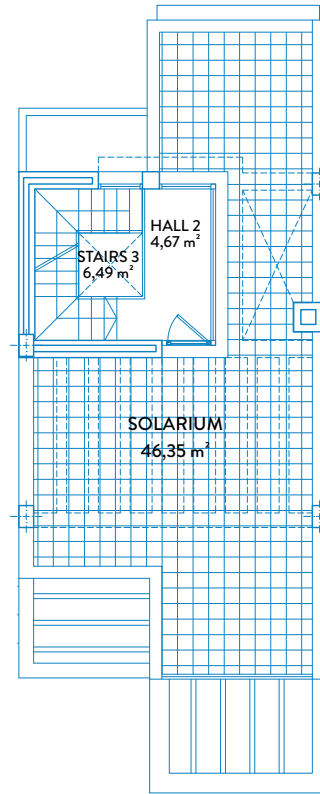

SOLARIUM

BUILT AREAS

Townhouse area	144,89 m ²
Basement area	59,40 m ²
Solarium area	46,35 m ²
Terrace area	51,18 m ²
Garden area	205,08 m ²

USEFUL AREAS

Townhouse area	112,81 m ²
Basement area	52,47 m ²

BOJA AREAS

Useful area	124,09 m ²
Built area	159,38 m ²

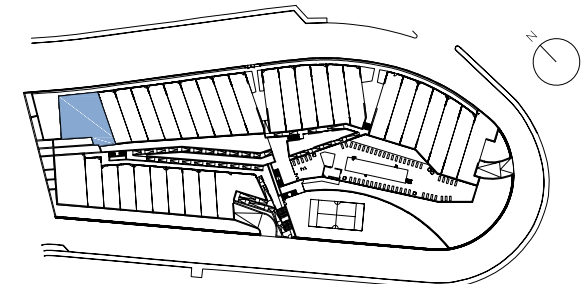

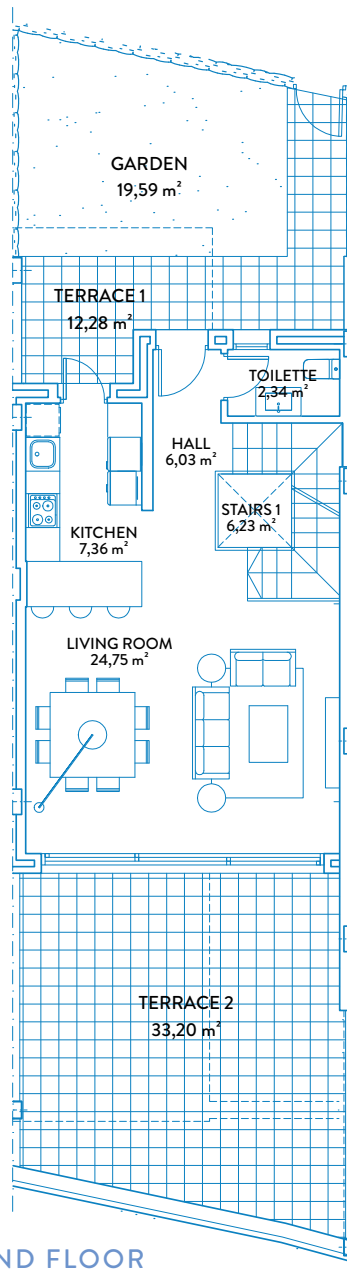

GROUND FLOOR

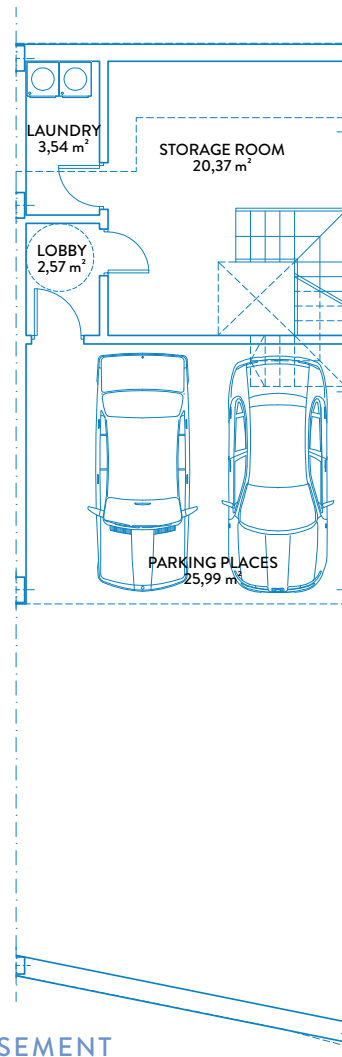

BASEMENT



BUILT AREAS

Townhouse area	139,34 m ²
Basement area	59,40 m ²
Solarium area	46,35 m ²
Terrace area	55,40 m ²
Garden area	16,59 m ²

USEFUL AREAS

Townhouse area	112,81 m ²
Basement area	52,47 m ²

BOJA AREAS

Useful area	124,09 m ²
Built area	153,27 m ²

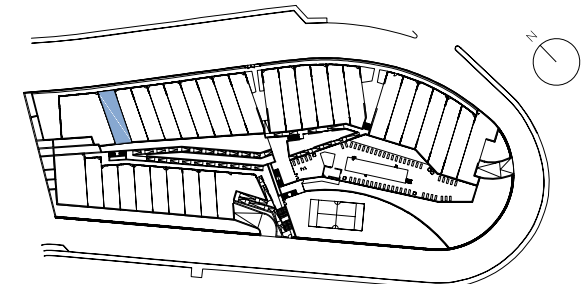

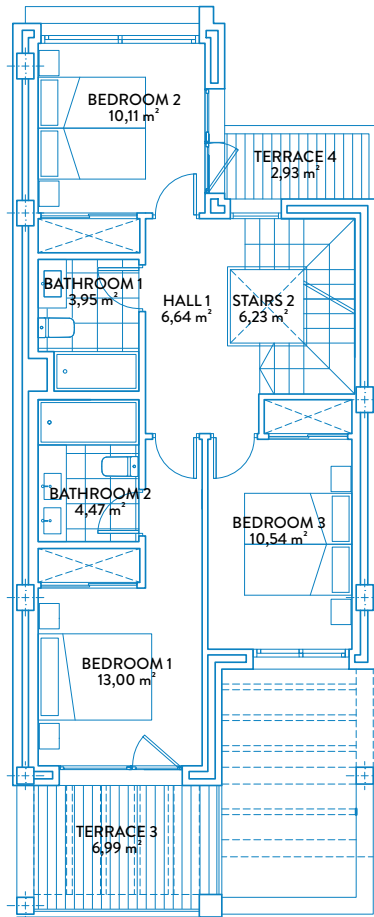

FIRST FLOOR

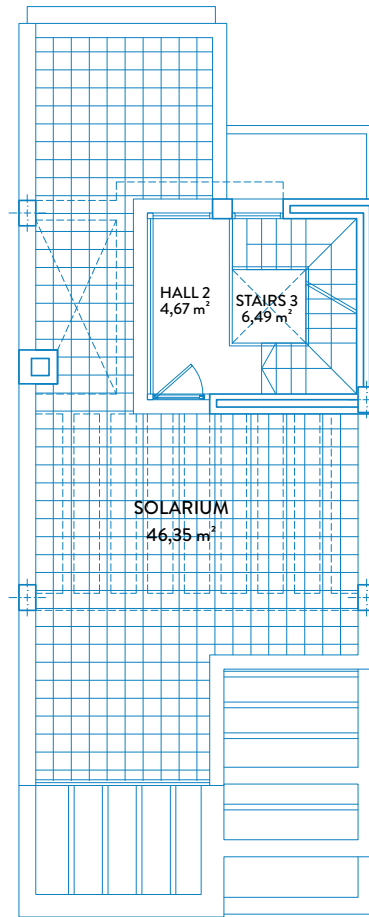

SOLARIUM



BUILT AREAS

Townhouse area	139,34 m ²
Basement area	59,40 m ²
Solarium area	46,35 m ²
Terrace area	55,40 m ²
Garden area	16,59 m ²

USEFUL AREAS

Townhouse area	112,81 m ²
Basement area	52,47 m ²

BOJA AREAS

Useful area	124,09 m ²
Built area	153,27 m ²

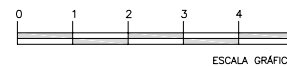
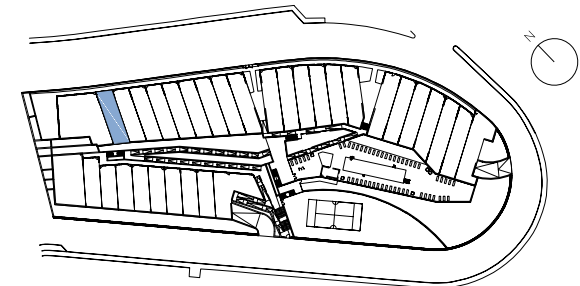

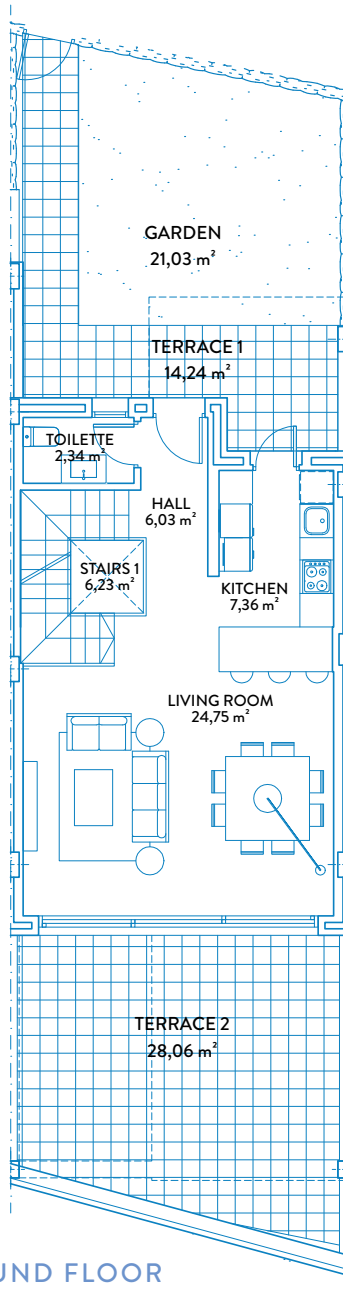

GROUND FLOOR

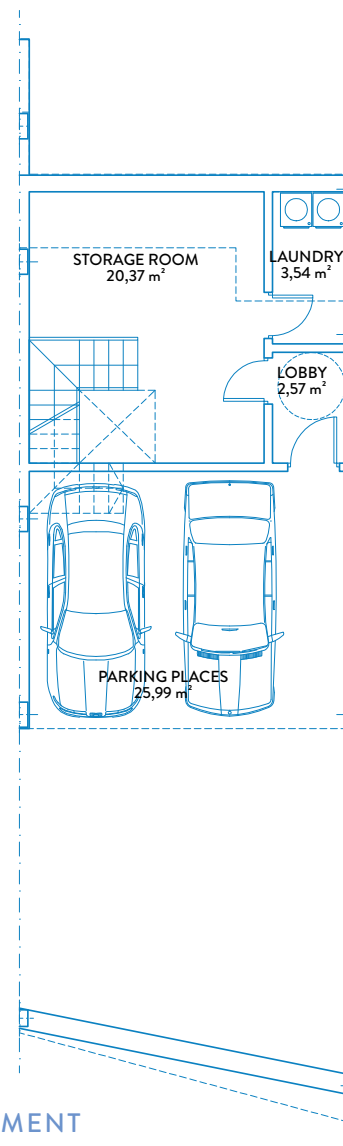

BASEMENT



BUILT AREAS

Townhouse area	139,34 m ²
Basement area	59,40 m ²
Solarium area	46,35 m ²
Terrace area	52,22 m ²
Garden area	21,03 m ²

USEFUL AREAS

Townhouse area	112,81 m ²
Basement area	52,47 m ²

BOJA AREAS

Useful area	124,09 m ²
Built area	153,27 m ²

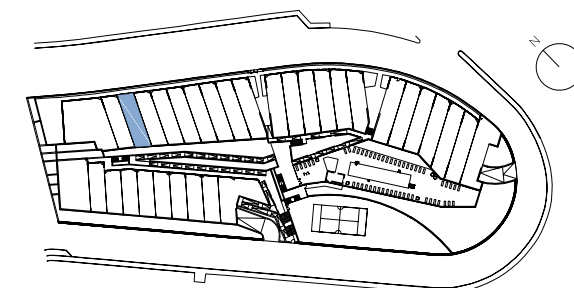

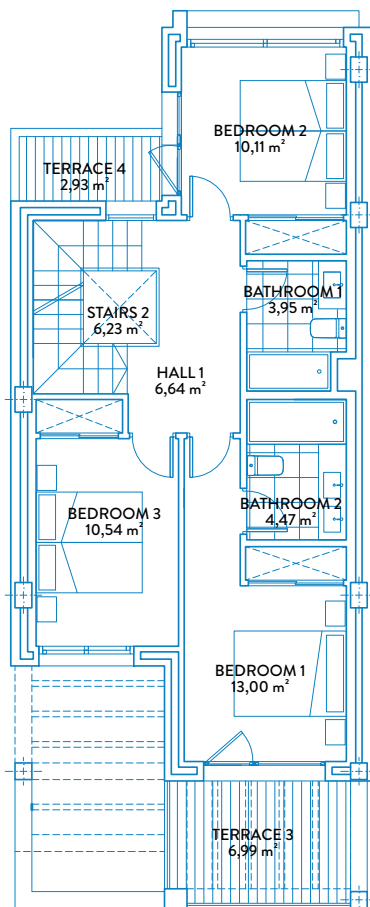

FIRST FLOOR

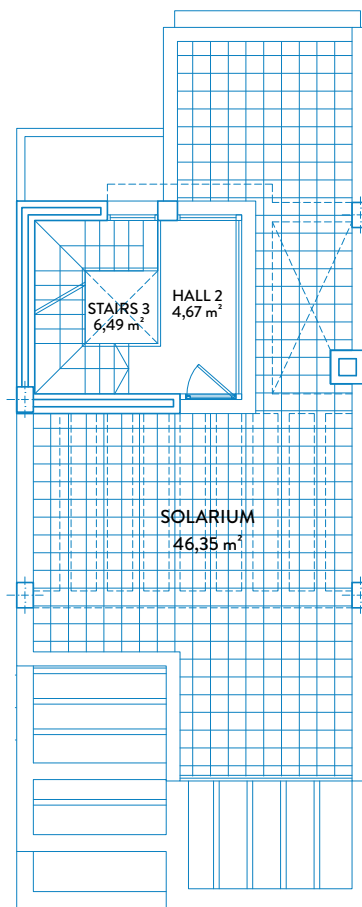

SOLARIUM

BUILT AREAS

Townhouse area	139,34 m ²
Basement area	59,40 m ²
Solarium area	46,35 m ²
Terrace area	52,22 m ²
Garden area	21,03 m ²

USEFUL AREAS

Townhouse area	112,81 m ²
Basement area	52,47 m ²

BOJA AREAS

Useful area	124,09 m ²
Built area	153,27 m ²

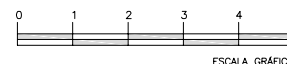
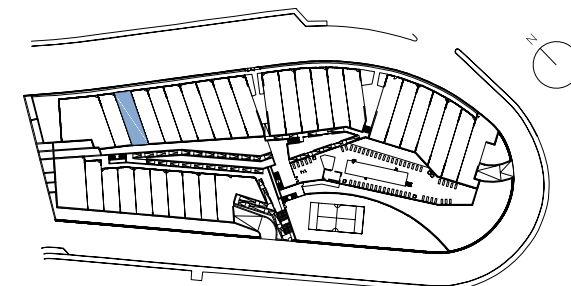

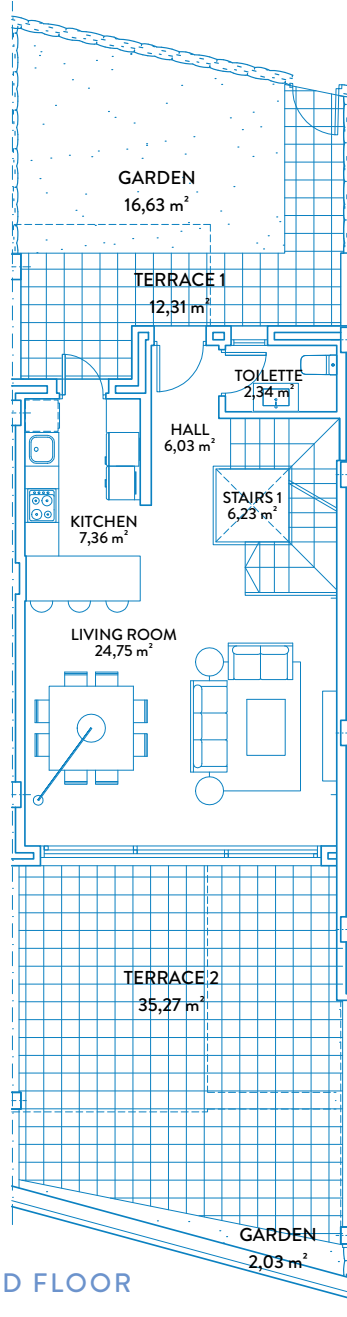

GROUND FLOOR

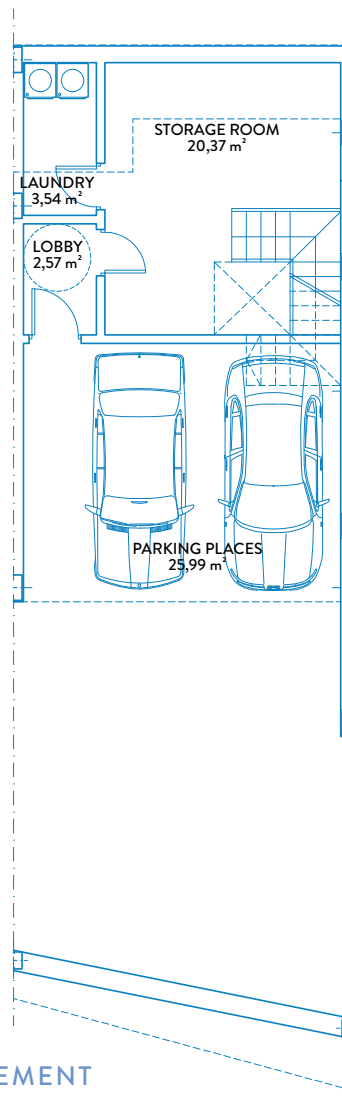

BASEMENT

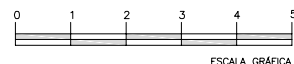

BUILT AREAS

Townhouse area	139,34 m ²
Basement area	59,40 m ²
Solarium area	46,35 m ²
Terrace area	57,50 m ²
Garden area	18,66 m ²

USEFUL AREAS

Townhouse area	112,81 m ²
Basement area	52,47 m ²

BOJA AREAS

Useful area	124,09 m ²
Built area	153,27 m ²

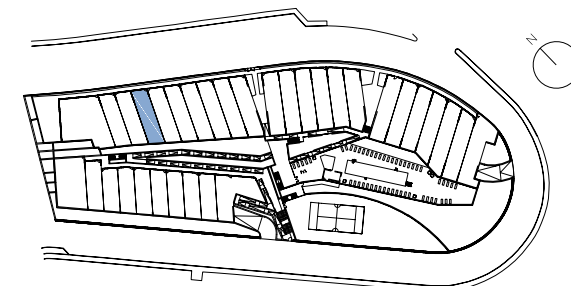

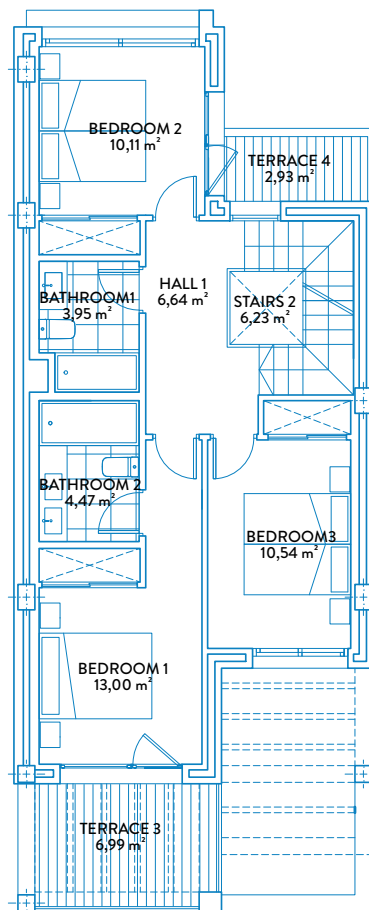

FIRST FLOOR

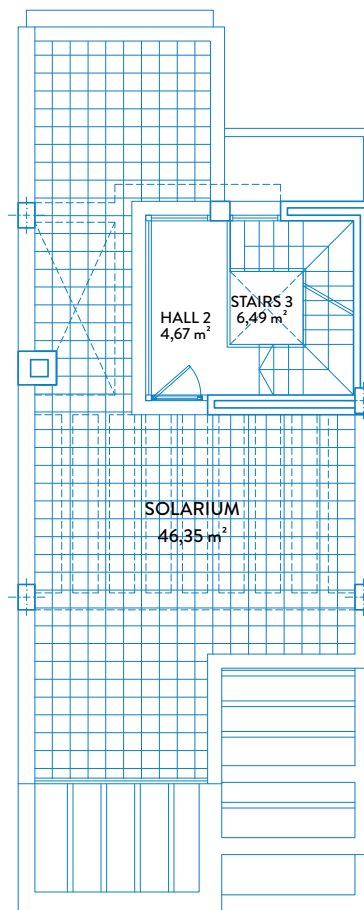

SOLARIUM



BUILT AREAS

Townhouse area	139,34 m ²
Basement area	59,40 m ²
Solarium area	46,35 m ²
Terrace area	57,50 m ²
Garden area	18,66 m ²

USEFUL AREAS

Townhouse area	112,81 m ²
Basement area	52,47 m ²

BOJA AREAS

Useful area	124,09 m ²
Built area	153,27 m ²

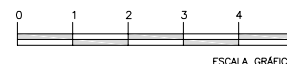
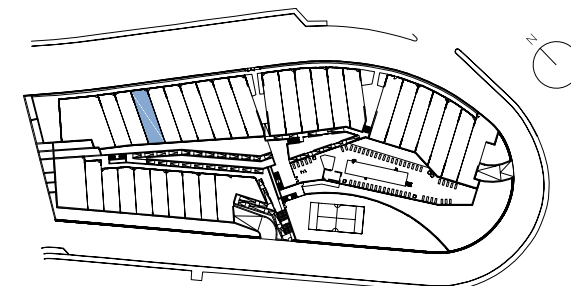

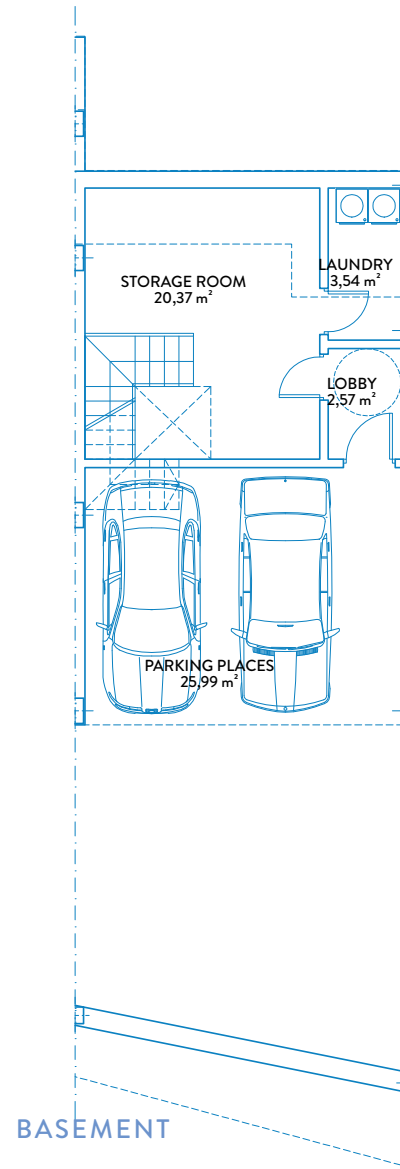
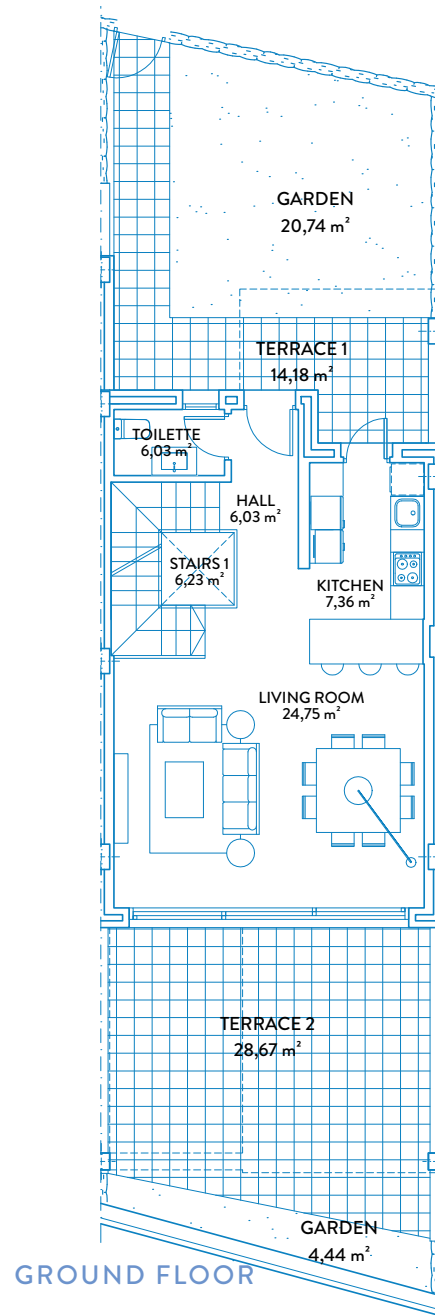

BUILT AREAS

Townhouse area	139,34 m ²
Basement area	59,40 m ²
Solarium area	46,35 m ²
Terrace area	52,77 m ²
Garden area	25,18 m ²

USEFUL AREAS

Townhouse area	112,81 m ²
Basement area	52,47 m ²

BOJA AREAS

Useful area	124,09 m ²
Built area	153,27 m ²

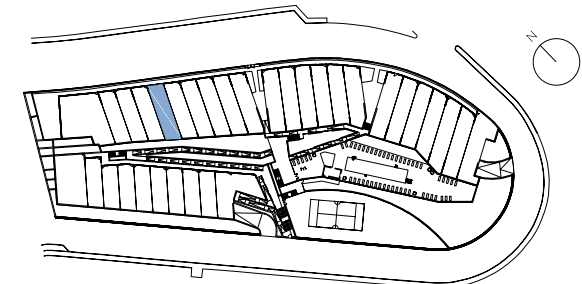

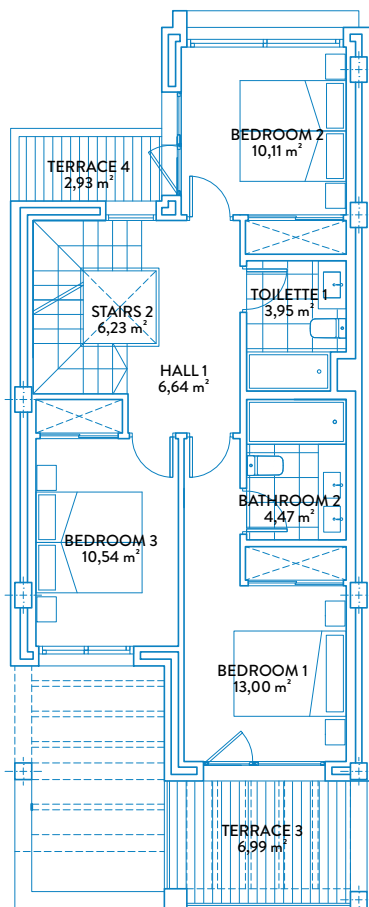

FIRST FLOOR

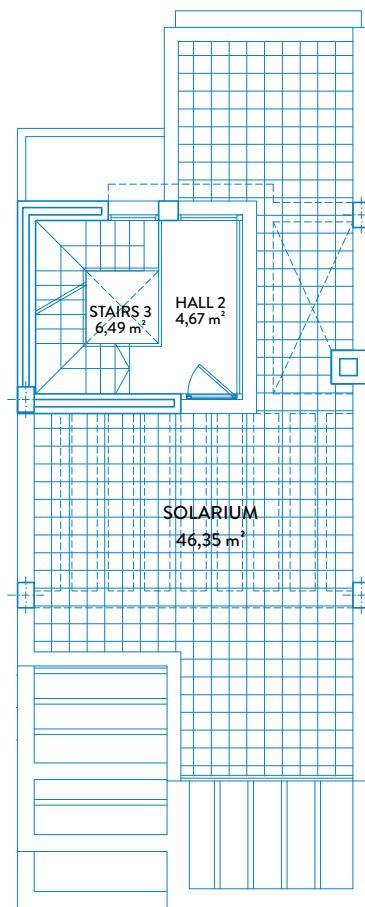

SOLARIUM



BUILT AREAS

Townhouse area	139,34 m ²
Basement area	59,40 m ²
Solarium area	46,35 m ²
Terrace area	52,77 m ²
Garden area	25,18 m ²

USEFUL AREAS

Townhouse area	112,81 m ²
Basement area	52,47 m ²

BOJA AREAS

Useful area	124,09 m ²
Built area	153,27 m ²

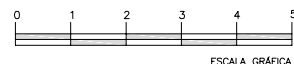
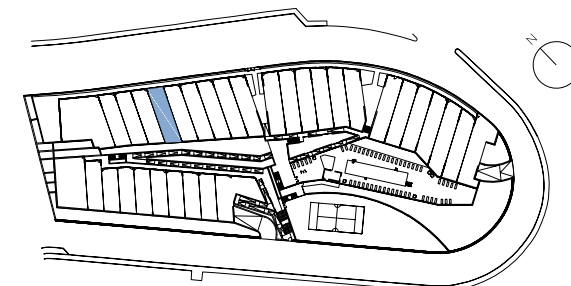

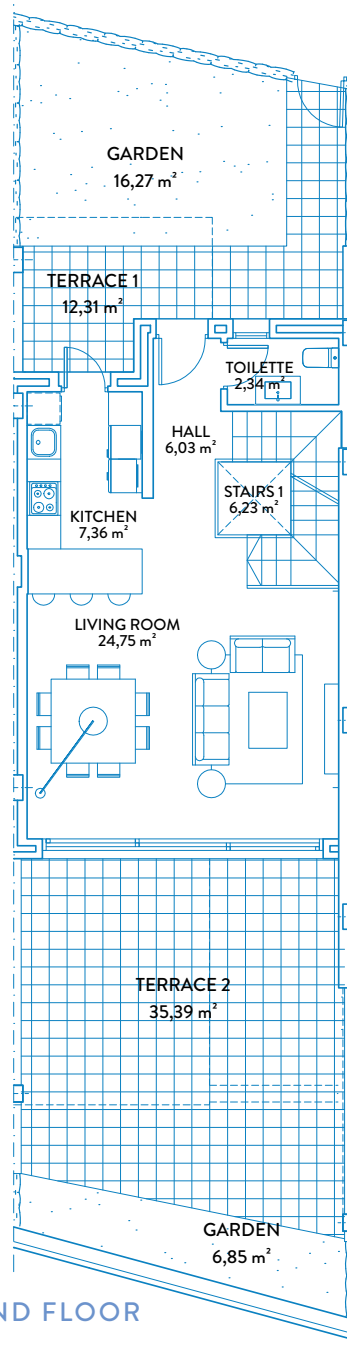

GROUND FLOOR

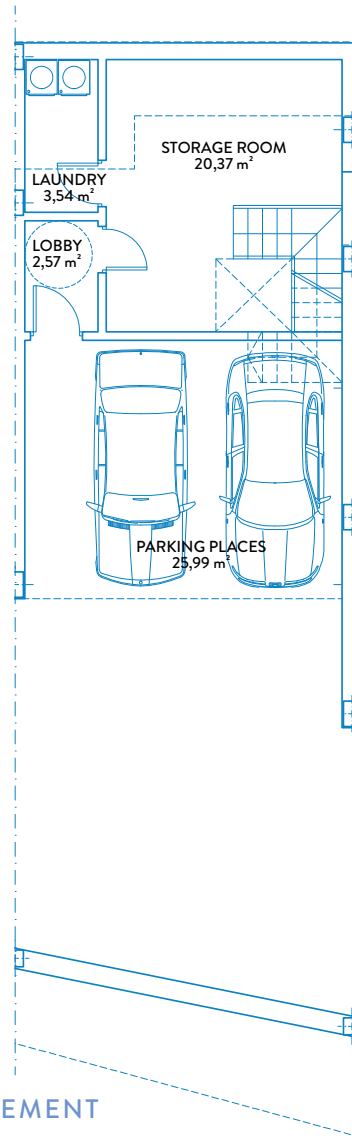

BASEMENT



BUILT AREAS

Townhouse area	139,34 m ²
Basement area	59,40 m ²
Solarium area	46,35 m ²
Terrace area	57,62 m ²
Garden area	23,12 m ²

USEFUL AREAS

Townhouse area	112,81 m ²
Basement area	52,47 m ²

BOJA AREAS

Useful area	124,09 m ²
Built area	153,27 m ²

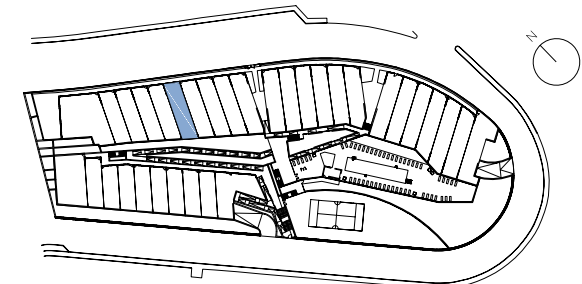

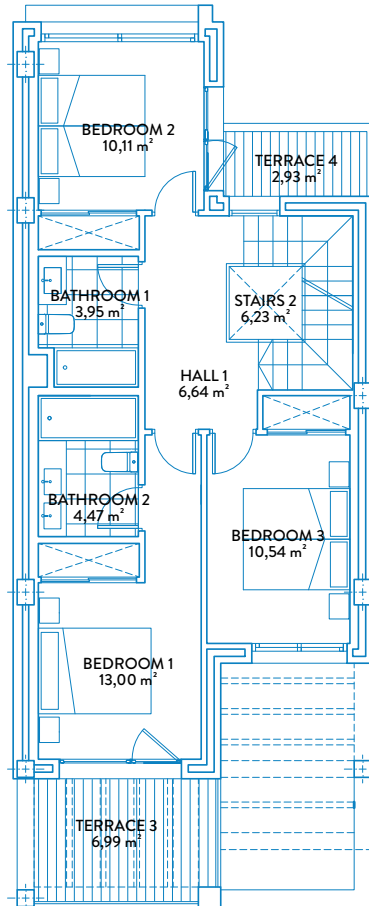

FIRST FLOOR

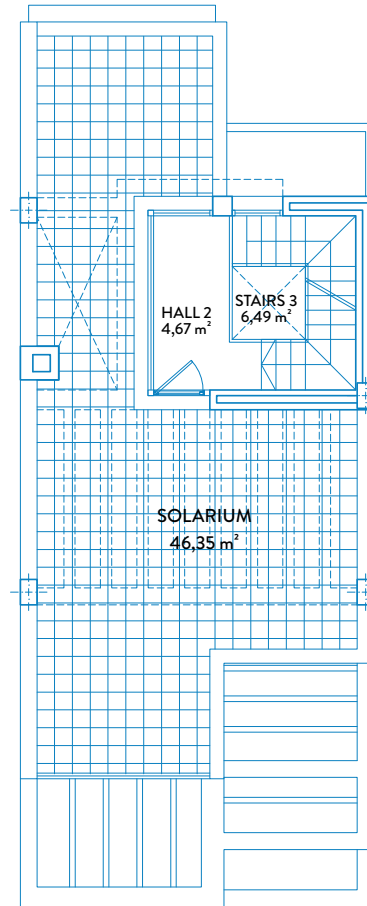

SOLARIUM



BUILT AREAS

Townhouse area	139,34 m ²
Basement area	59,40 m ²
Solarium area	46,35 m ²
Terrace area	57,62 m ²
Garden area	23,12 m ²

USEFUL AREAS

Townhouse area	112,81 m ²
Basement area	52,47 m ²

BOJA AREAS

Useful area	124,09 m ²
Built area	153,27 m ²

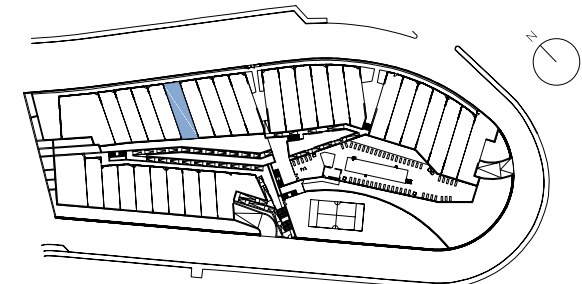

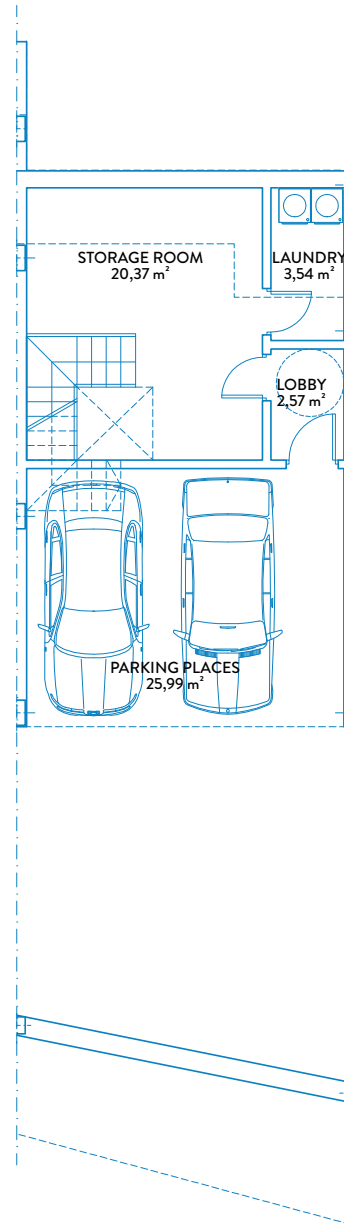
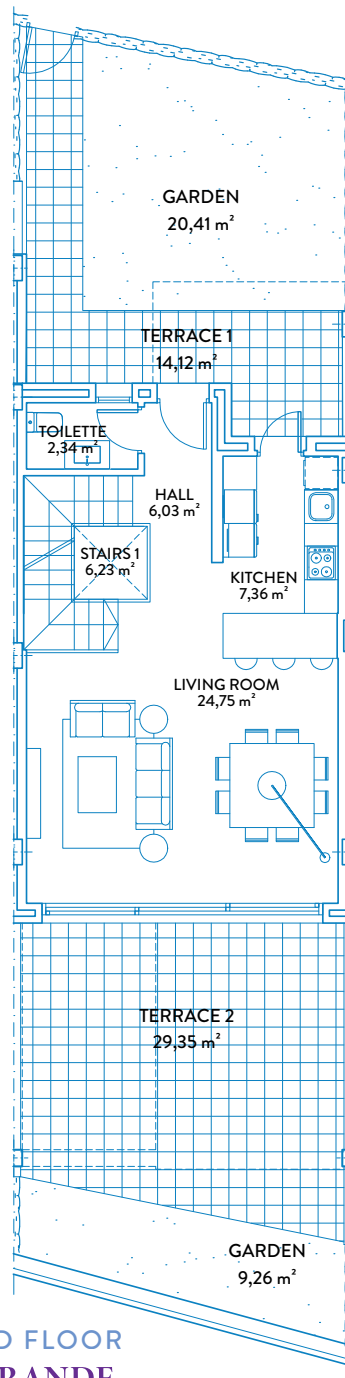

BASEMENT



BUILT AREAS

Townhouse area	139,34 m ²
Basement area	59,40 m ²
Solarium area	46,35 m ²
Terrace area	53,39 m ²
Garden area	29,67 m ²

USEFUL AREAS

Townhouse area	112,81 m ²
Basement area	52,47 m ²

BOJA AREAS

Useful area	124,09 m ²
Built area	153,27 m ²

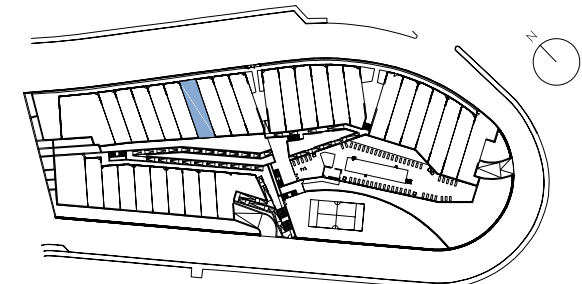

GROUND FLOOR

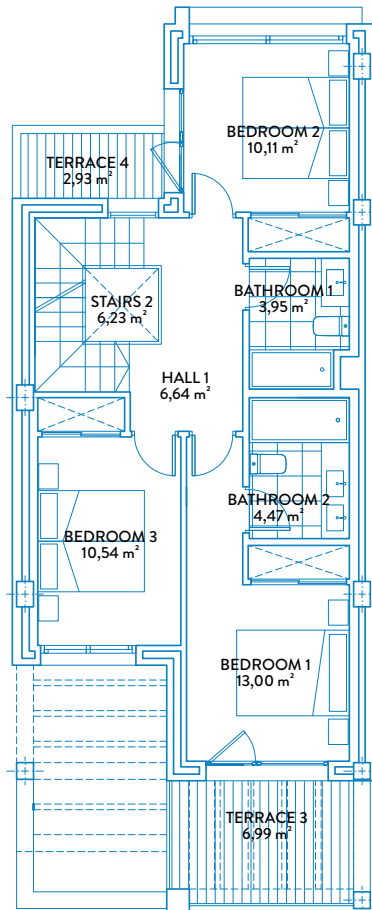

FIRST FLOOR

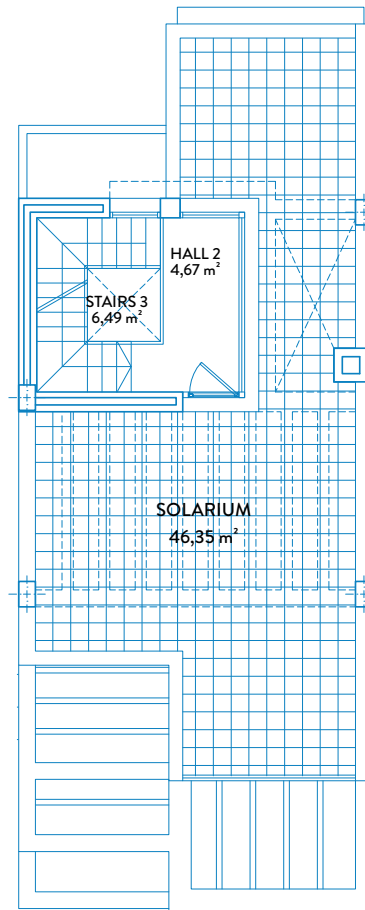

SOLARIUM



BUILT AREAS

Townhouse area	139,34 m ²
Basement area	59,40 m ²
Solarium area	46,35 m ²
Terrace area	53,39 m ²
Garden area	29,67 m ²

USEFUL AREAS

Townhouse area	112,81 m ²
Basement area	52,47 m ²

BOJA AREAS

Useful area	124,09 m ²
Built area	153,27 m ²

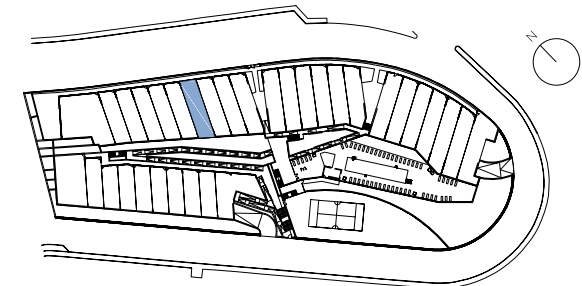

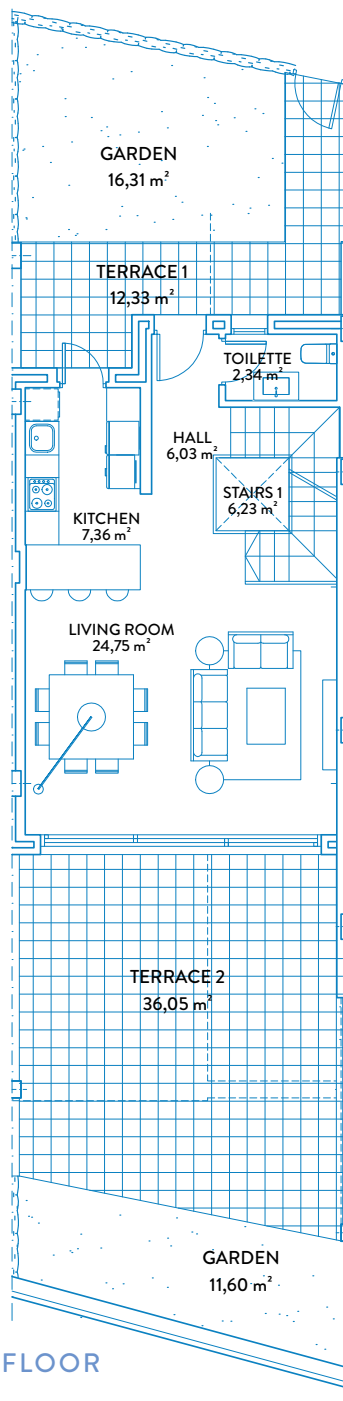

GROUND FLOOR

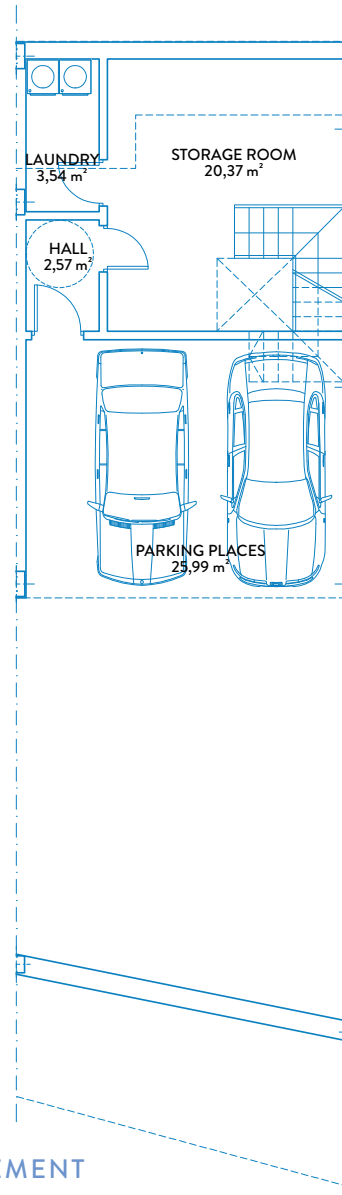

BASEMENT



BUILT AREAS

Townhouse area	139,34 m ²
Basement area	59,40 m ²
Solarium area	46,35 m ²
Terrace area	58,30 m ²
Garden area	27,91 m ²

USEFUL AREAS

Townhouse area	112,81 m ²
Basement area	52,47 m ²

BOJA AREAS

Useful area	124,09 m ²
Built area	153,27 m ²

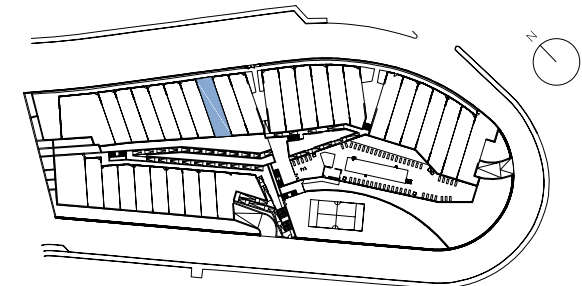

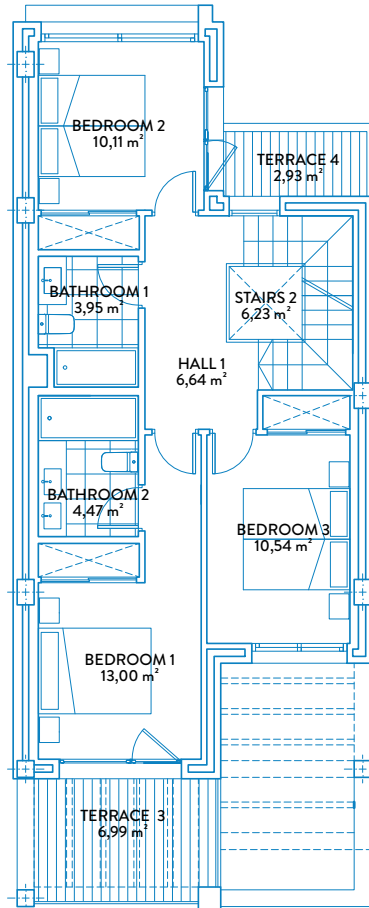

FIRST FLOOR

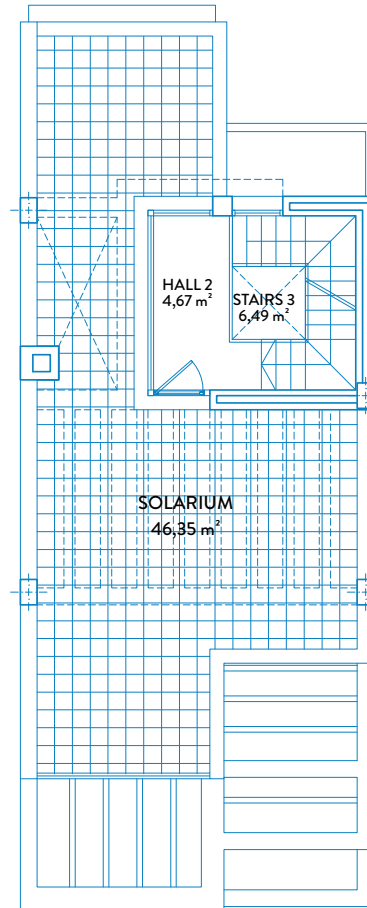

SOLARIUM



BUILT AREAS

Townhouse area	139,34 m ²
Basement area	59,40 m ²
Solarium area	46,35 m ²
Terrace area	58,30 m ²
Garden area	27,91 m ²

USEFUL AREAS

Townhouse area	112,81 m ²
Basement area	52,47 m ²

BOJA AREAS

Useful area	124,09 m ²
Built area	153,27 m ²

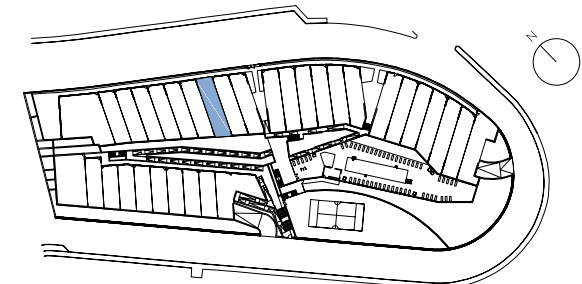

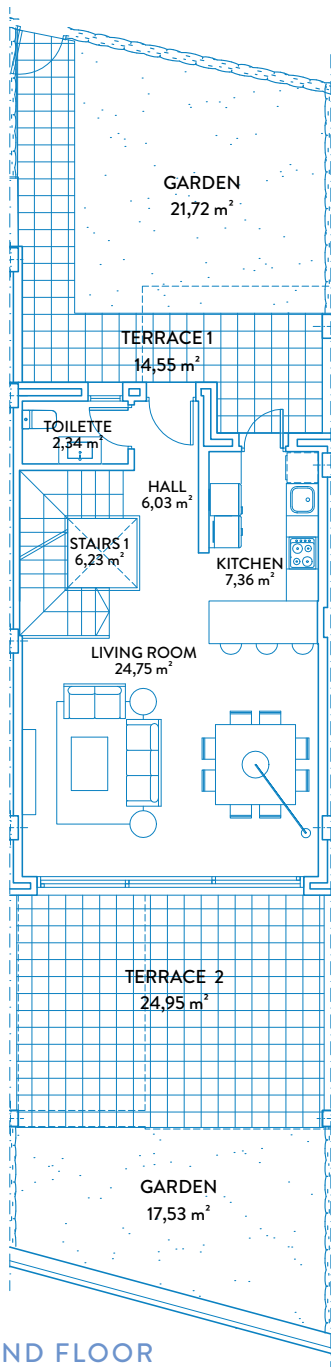

GROUND FLOOR

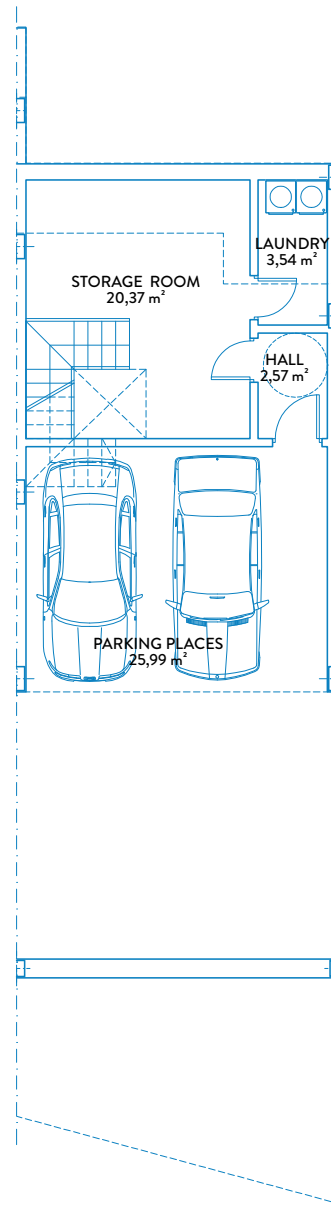

BASEMENT



TOWNHOUSE 09
 TIPE A
 GROUND FLOOR & BASEMENT



BUILT AREAS

Townhouse area	139,34 m ²
Basement area	59,40 m ²
Solarium area	46,35 m ²
Terrace area	49,42 m ²
Garden area	39,25 m ²

USEFUL AREAS

Townhouse area	112,81 m ²
Basement area	52,47 m ²

BOJA AREAS

Useful area	124,09 m ²
Built area	153,27 m ²

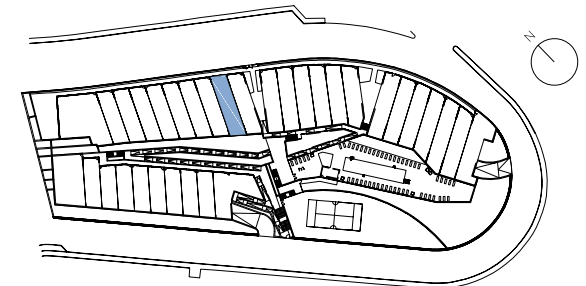

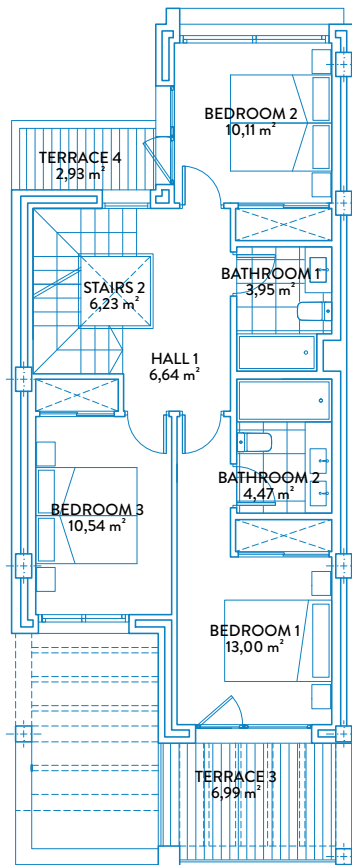

FIRST FLOOR

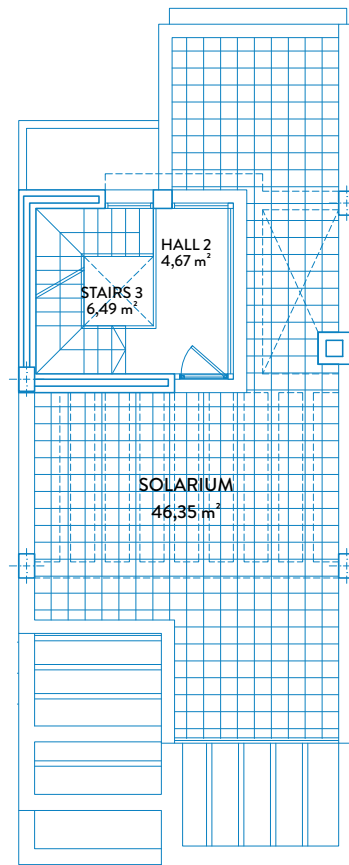

SOLARIUM



BUILT AREAS

Townhouse area	139,34 m ²
Basement area	59,40 m ²
Solarium area	46,35 m ²
Terrace area	49,42 m ²
Garden area	39,25 m ²

USEFUL AREAS

Townhouse area	112,81 m ²
Basement area	52,47 m ²

BOJA AREAS

Useful area	124,09 m ²
Built area	153,27 m ²

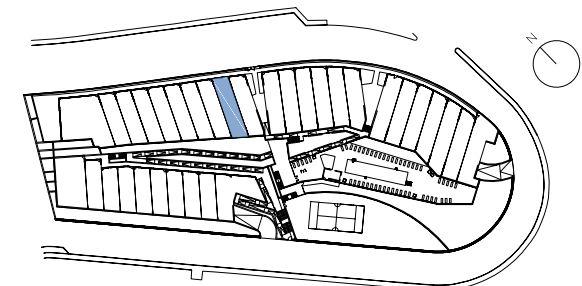

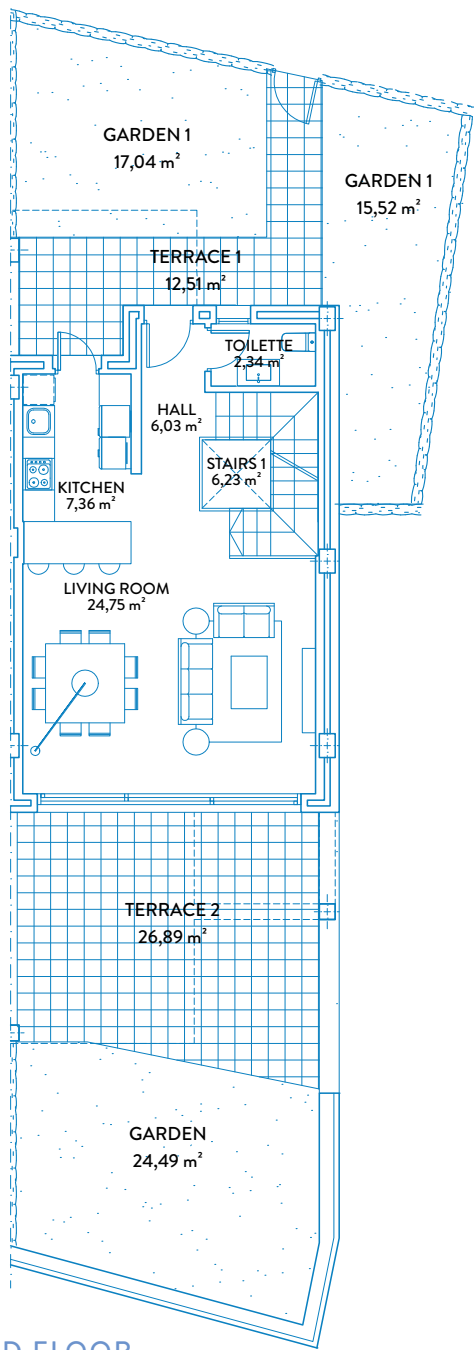

GROUND FLOOR

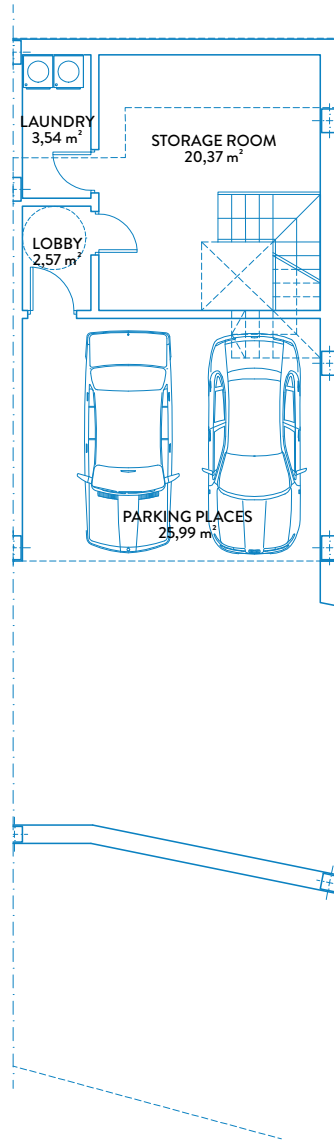

BASEMENT

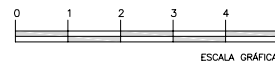

TOWNHOUSE 10
 TIPE A1
 GROUND FLOOR & BASEMENT



BUILT AREAS

Townhouse area	144,89 m ²
Basement area	59,40 m ²
Solarium area	46,35 m ²
Terrace area	49,32 m ²
Garden area	57,05 m ²

USEFUL AREAS

Townhouse area	112,81 m ²
Basement area	52,47 m ²

BOJA AREAS

Useful area	124,09 m ²
Built area	159,38 m ²

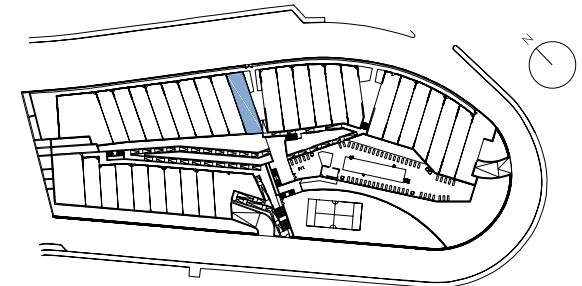

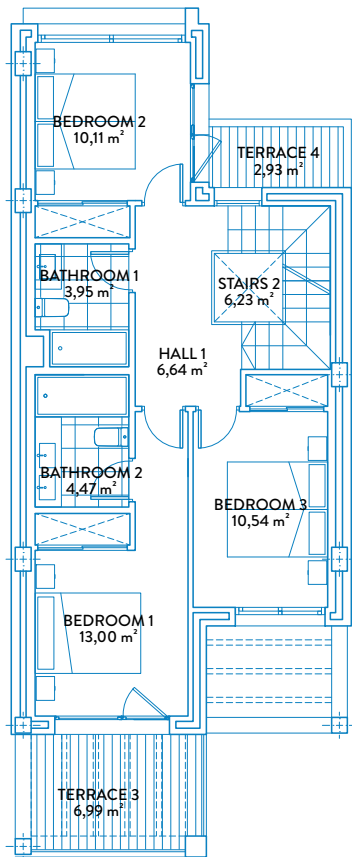

FIRST FLOOR

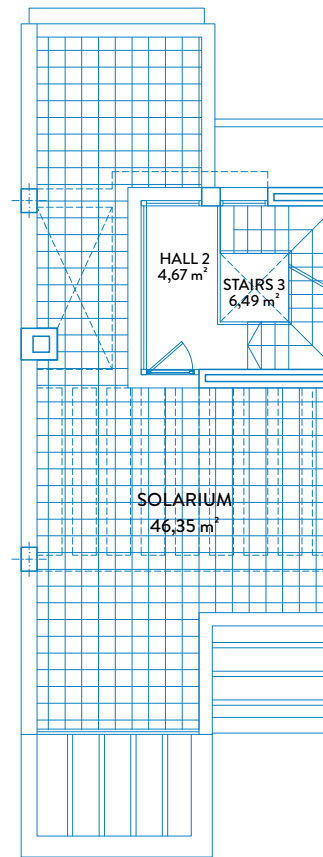

SOLARIUM

BUILT AREAS

Townhouse area	144,89 m ²
Basement area	59,40 m ²
Solarium area	46,35 m ²
Terrace area	49,32 m ²
Garden area	57,05 m ²

USEFUL AREAS

Townhouse area	112,81 m ²
Basement area	52,47 m ²

BOJA AREAS

Useful area	124,09 m ²
Built area	159,38 m ²

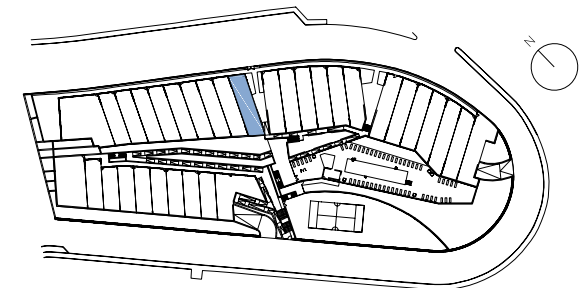

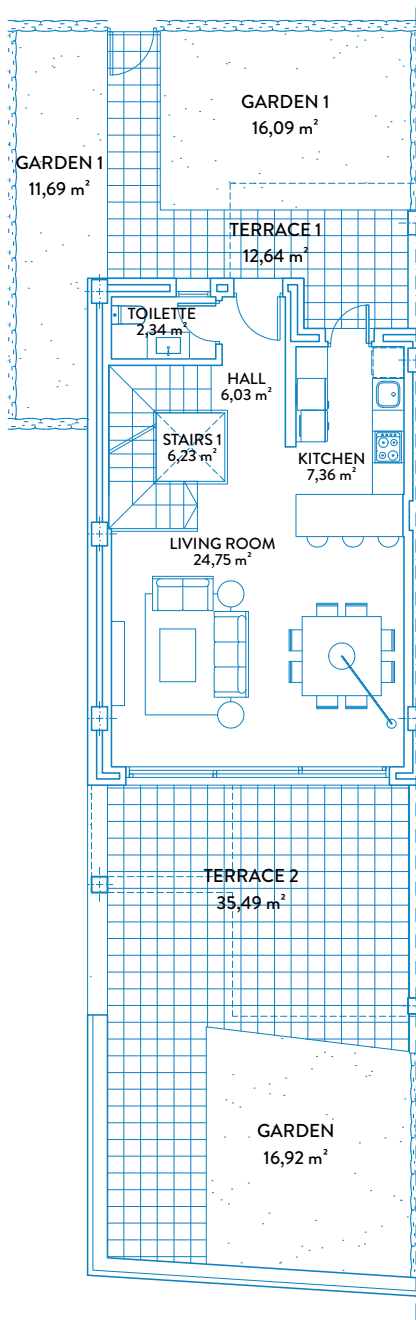

GROUND FLOOR

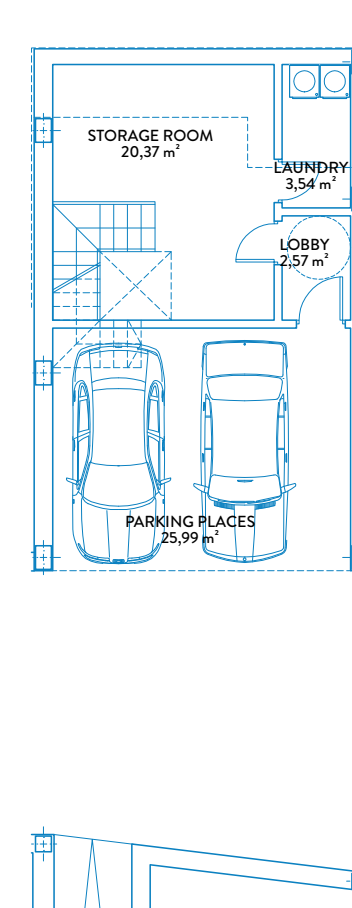

BASEMENT

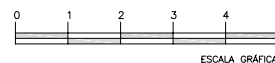

TOWNHOUSE 11
 TIPE A1
 GROUND FLOOR & BASEMENT



BUILT AREAS

Townhouse area	144,89 m ²
Basement area	59,40 m ²
Solarium area	46,35 m ²
Terrace area	58,05 m ²
Garden area	44,70 m ²

USEFUL AREAS

Townhouse area	112,81 m ²
Basement area	52,47 m ²

BOJA AREAS

Useful area	124,09 m ²
Built area	159,38 m ²

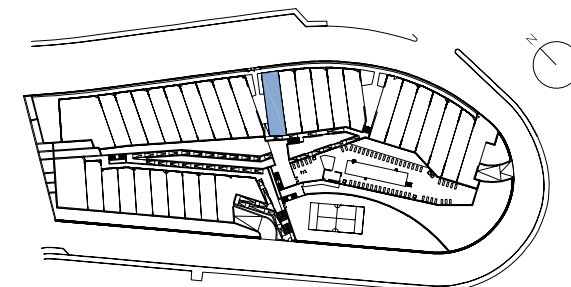

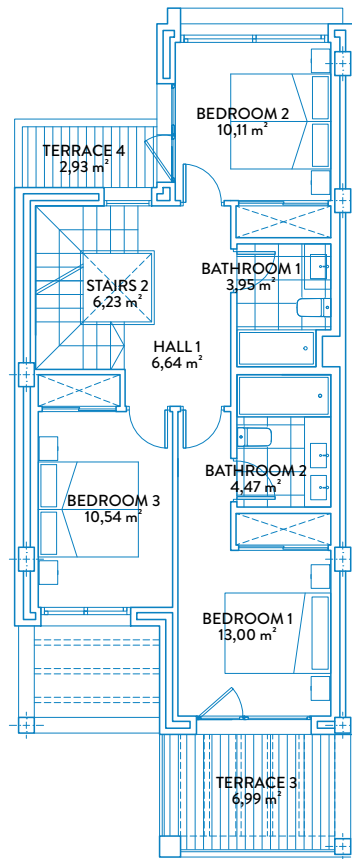

FIRST FLOOR

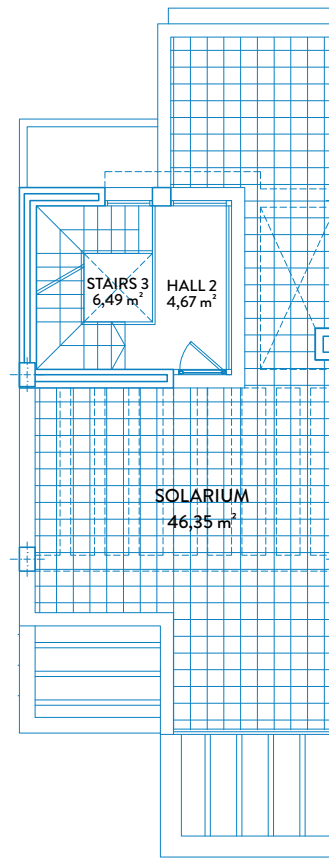

SOLARIUM



BUILT AREAS

Townhouse area	144,89 m ²
Basement area	59,40 m ²
Solarium area	46,35 m ²
Terrace area	58,05 m ²
Garden area	44,70 m ²

USEFUL AREAS

Townhouse area	112,81 m ²
Basement area	52,47 m ²

BOJA AREAS

Useful area	124,09 m ²
Built area	159,38 m ²

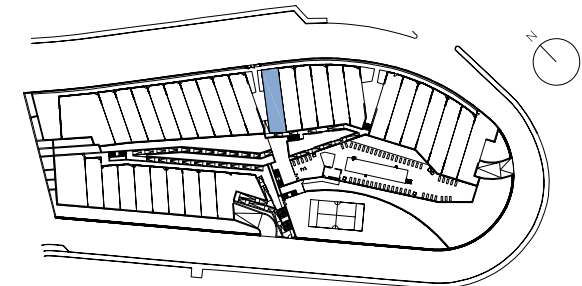

TOWNHOUSE 12

TIPE A

GROUND FLOOR & BASEMENT

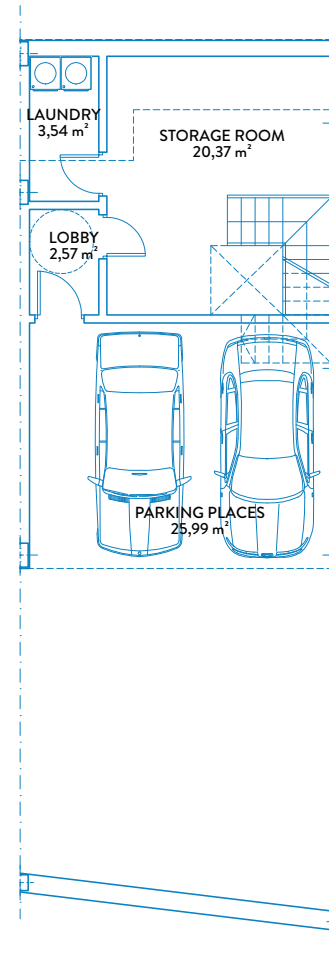
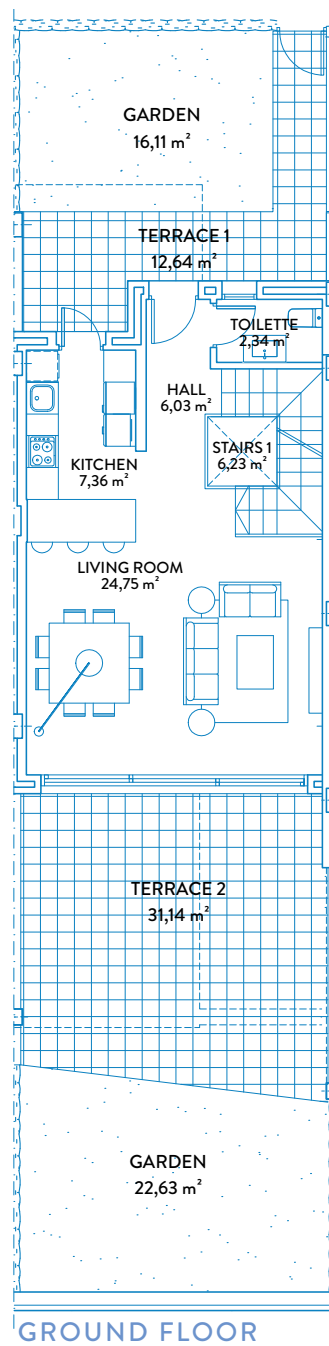

BASEMENT



BUILT AREAS

Townhouse area	139,34 m ²
Basement area	59,40 m ²
Solarium area	46,35 m ²
Terrace area	53,70 m ²
Garden area	38,74 m ²

USEFUL AREAS

Townhouse area	112,81 m ²
Basement area	52,47 m ²

BOJA AREAS

Useful area	124,09 m ²
Built area	153,27 m ²

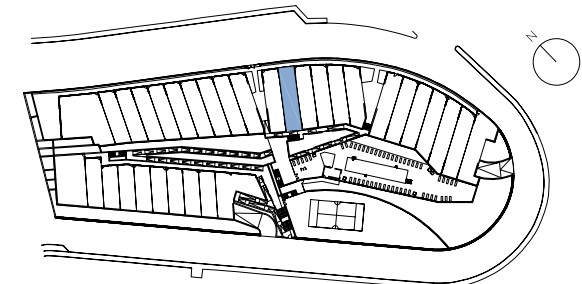

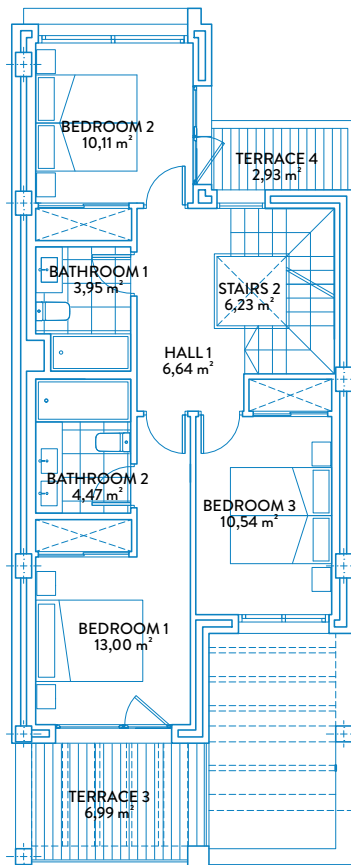

FIRST FLOOR

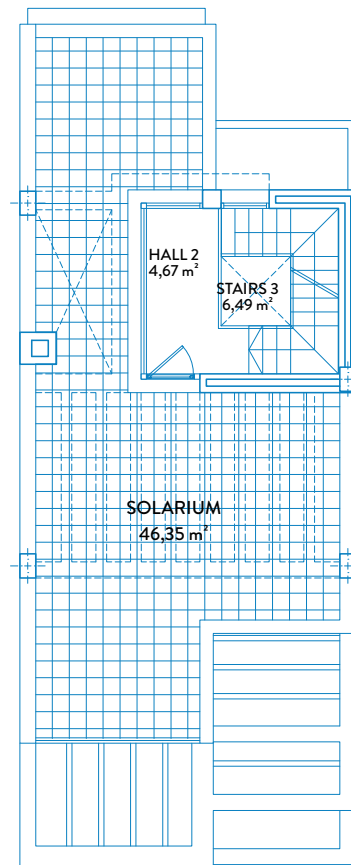

SOLARIUM



BUILT AREAS

Townhouse area	139,34 m ²
Basement area	59,40 m ²
Solarium area	46,35 m ²
Terrace area	53,70 m ²
Garden area	38,74 m ²

USEFUL AREAS

Townhouse area	112,81 m ²
Basement area	52,47 m ²

BOJA AREAS

Useful area	124,09 m ²
Built area	153,27 m ²

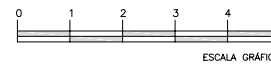
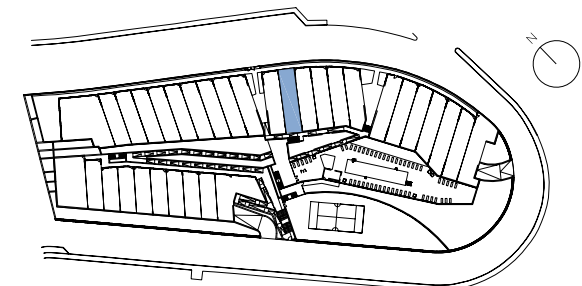

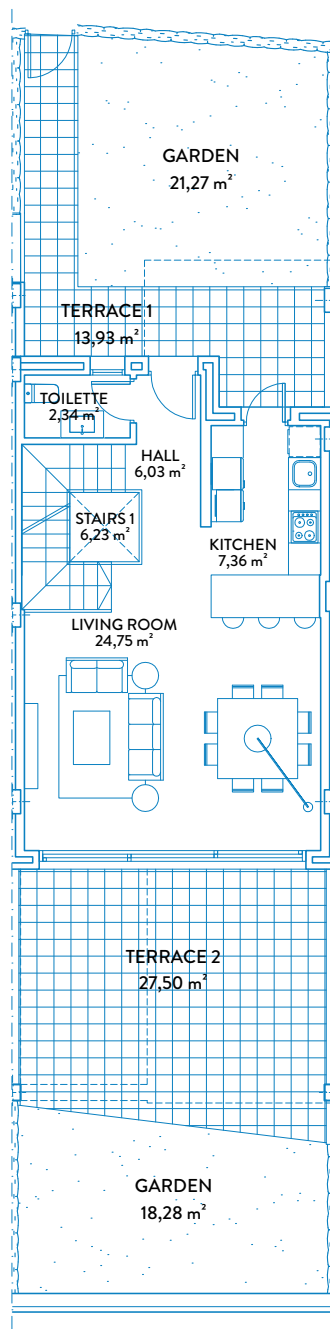

GROUND FLOOR

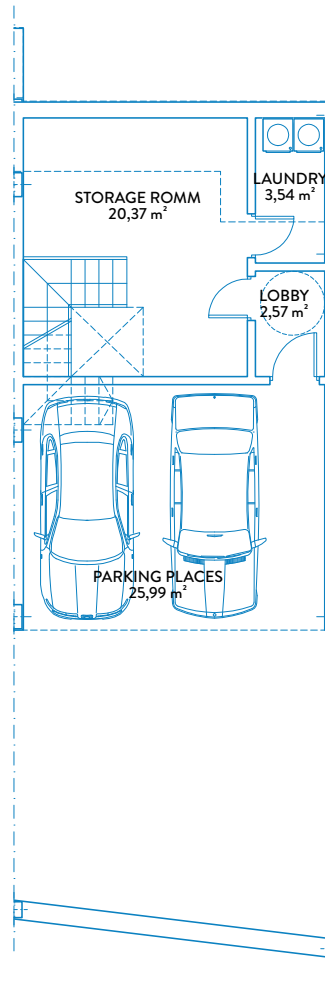

BASEMENT



TOWNHOUSE 13
 TIPE A
 GROUND FLOOR & BASEMENT



BUILT AREAS

Townhouse area	139,34 m ²
Basement area	59,40 m ²
Solarium area	46,35 m ²
Terrace area	51,35 m ²
Garden area	39,55 m ²

USEFUL AREAS

Townhouse area	112,81 m ²
Basement area	52,47 m ²

BOJA AREAS

Useful area	124,09 m ²
Built area	153,27 m ²

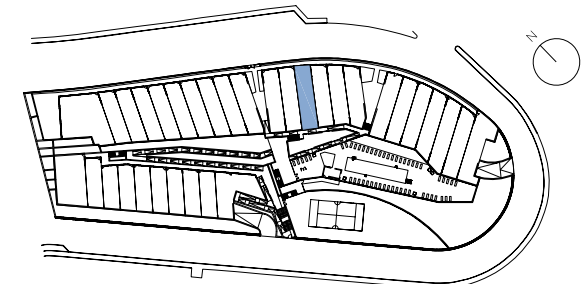

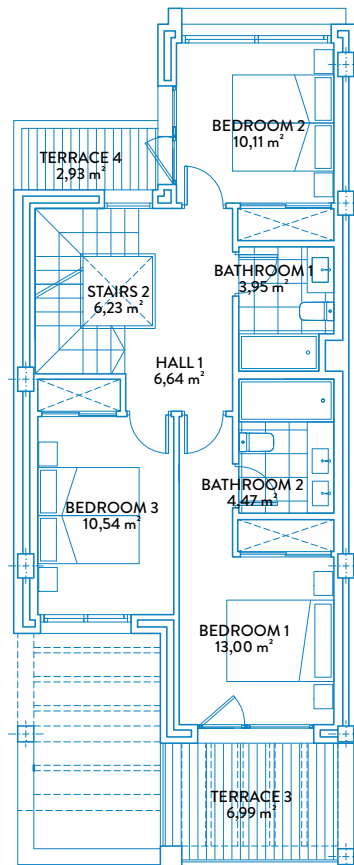

FIRST FLOOR

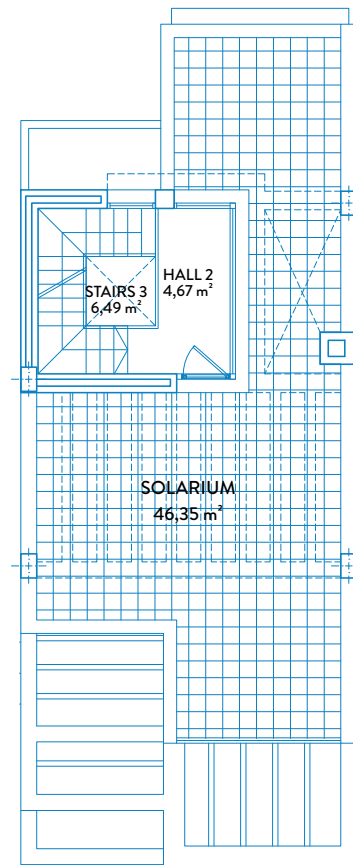

SOLARIUM



BUILT AREAS

Townhouse area	139,34 m ²
Basement area	59,40 m ²
Solarium area	46,35 m ²
Terrace area	51,35 m ²
Garden area	39,55 m ²

USEFUL AREAS

Townhouse area	112,81 m ²
Basement area	52,47 m ²

BOJA AREAS

Useful area	124,09 m ²
Built area	153,27 m ²

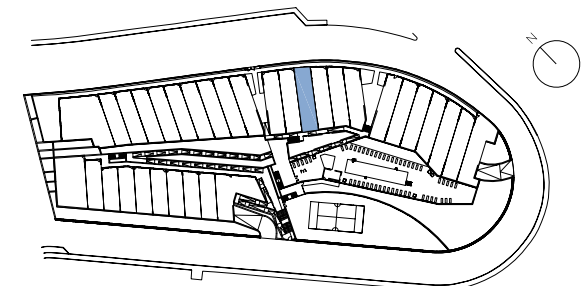

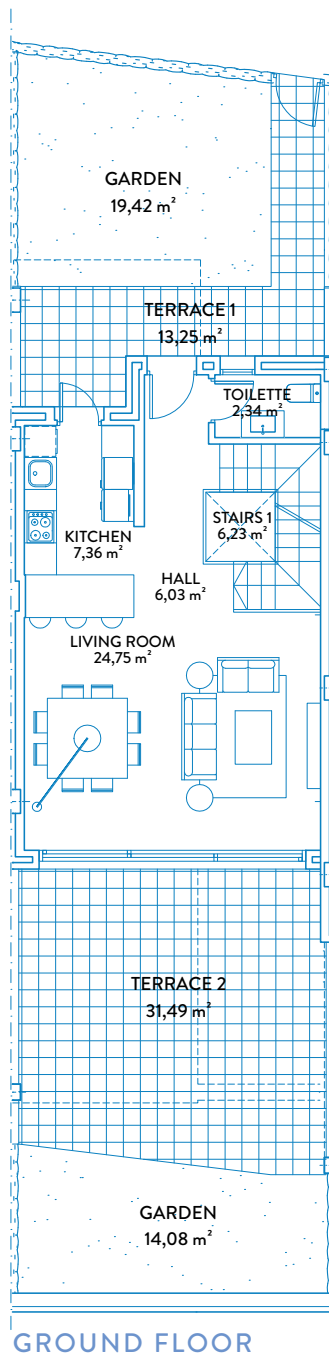

GROUND FLOOR

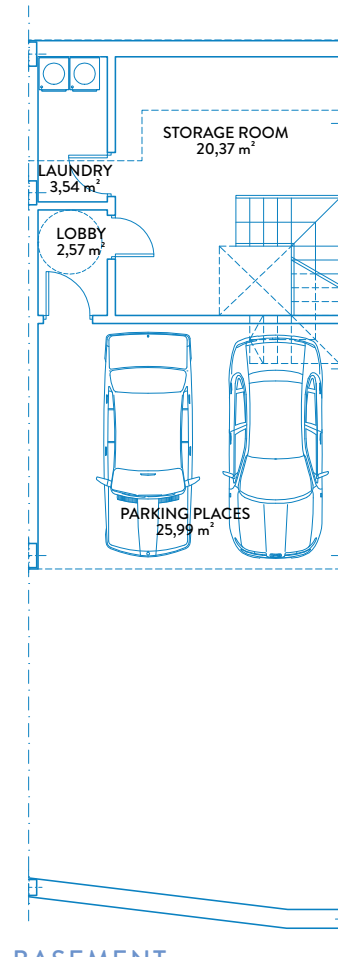

BASEMENT



ESCALA GRAFICA

BUILT AREAS

Townhouse area	139,34 m ²
Basement area	59,40 m ²
Solarium area	46,35 m ²
Terrace area	54,66 m ²
Garden area	33,50 m ²

USEFUL AREAS

Townhouse area	112,81 m ²
Basement area	52,47 m ²

BOJA AREAS

Useful area	124,09 m ²
Built area	153,27 m ²

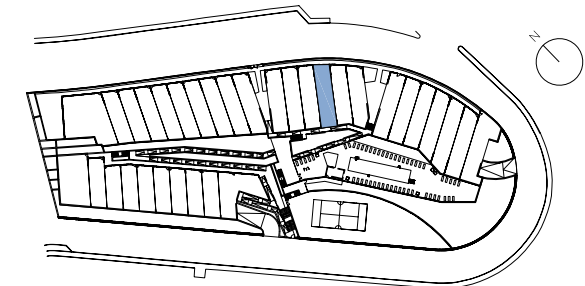

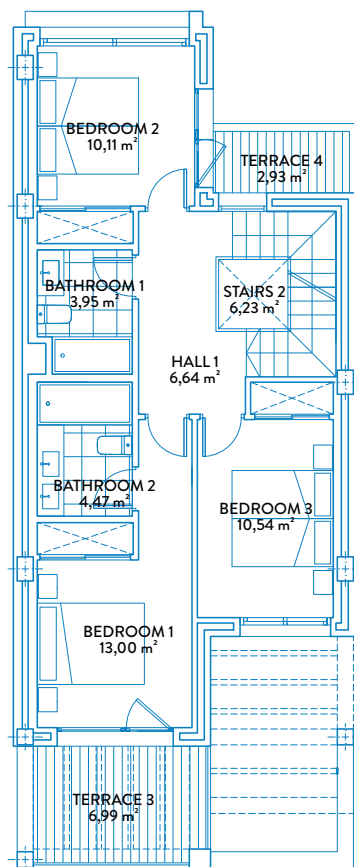

FIRST FLOOR

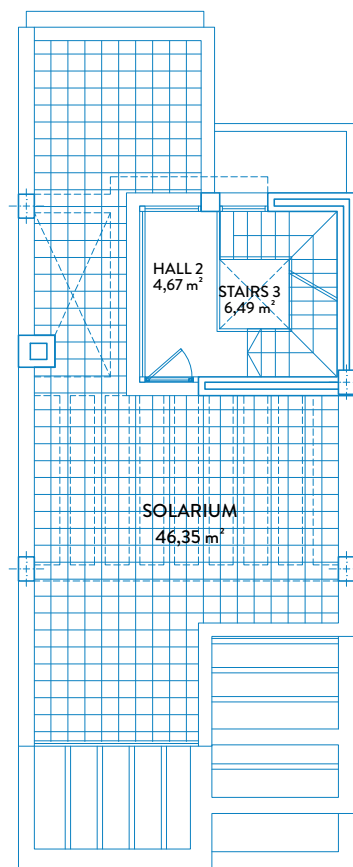

SOLARIUM



BUILT AREAS

Townhouse area	139,34 m ²
Basement area	59,40 m ²
Solarium area	46,35 m ²
Terrace area	54,66 m ²
Garden area	33,50 m ²

USEFUL AREAS

Townhouse area	112,81 m ²
Basement area	52,47 m ²

BOJA AREAS

Useful area	124,09 m ²
Built area	153,27 m ²

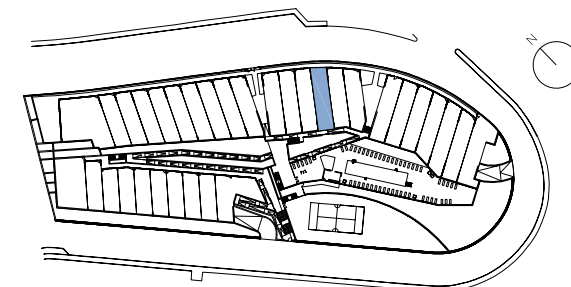

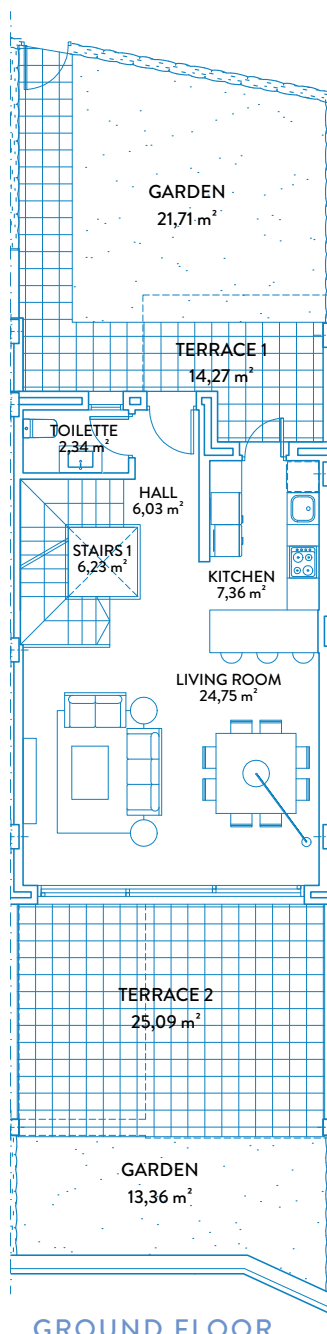

GROUND FLOOR

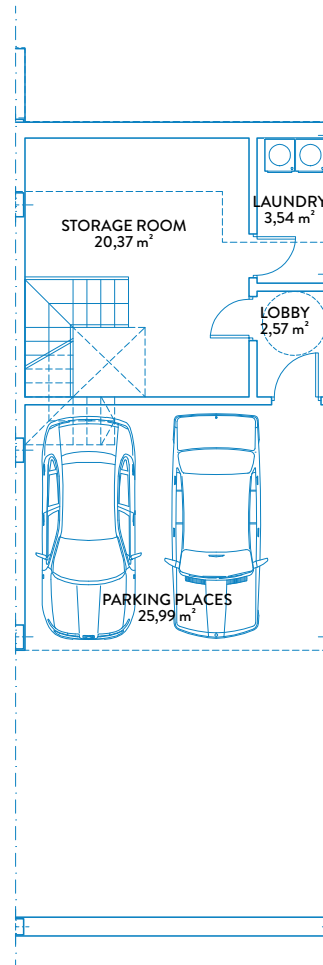

BASEMENT

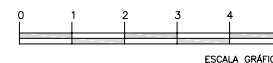

ESCALA GRÁFICA

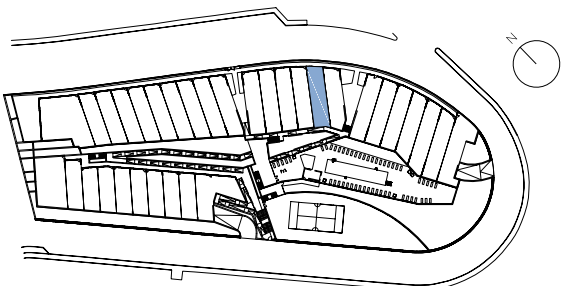

BUILT AREAS

Townhouse area	139,34 m ²
Basement area	59,40 m ²
Solarium area	46,35 m ²
Terrace area	49,28 m ²
Garden area	35,07 m ²

USEFUL AREAS

Townhouse area	112,81 m ²
Basement area	52,47 m ²

BOJA AREAS

Useful area	124,09 m ²
Built area	153,27 m ²

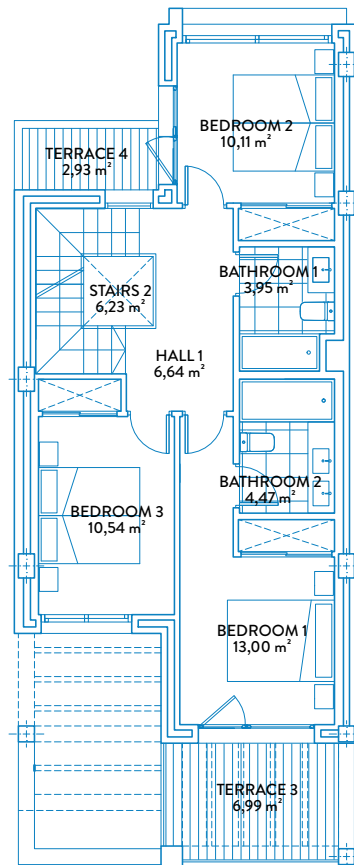

FIRST FLOOR

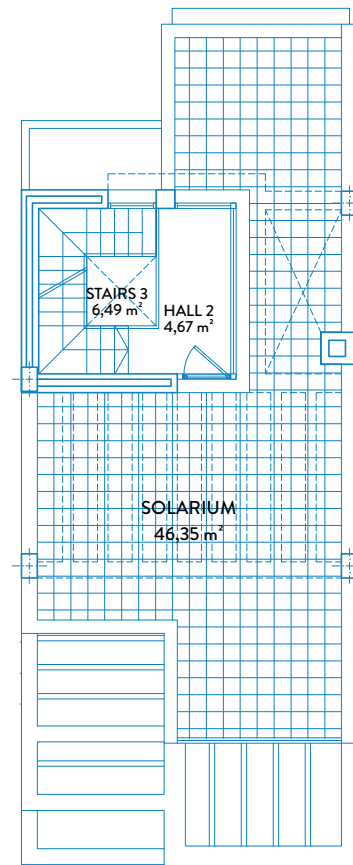

SOLARIUM



BUILT AREAS

Townhouse area	139,34 m ²
Basement area	59,40 m ²
Solarium area	46,35 m ²
Terrace area	49,28 m ²
Garden area	35,07 m ²

USEFUL AREAS

Townhouse area	112,81 m ²
Basement area	52,47 m ²

BOJA AREAS

Useful area	124,09 m ²
Built area	153,27 m ²

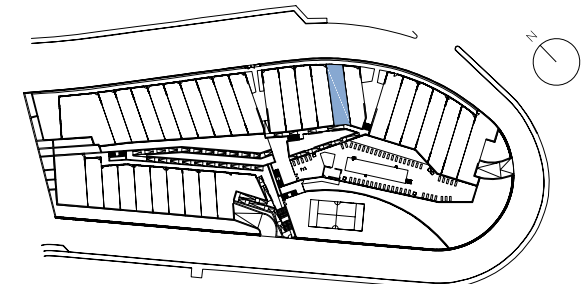

ESCALA GRAFICA

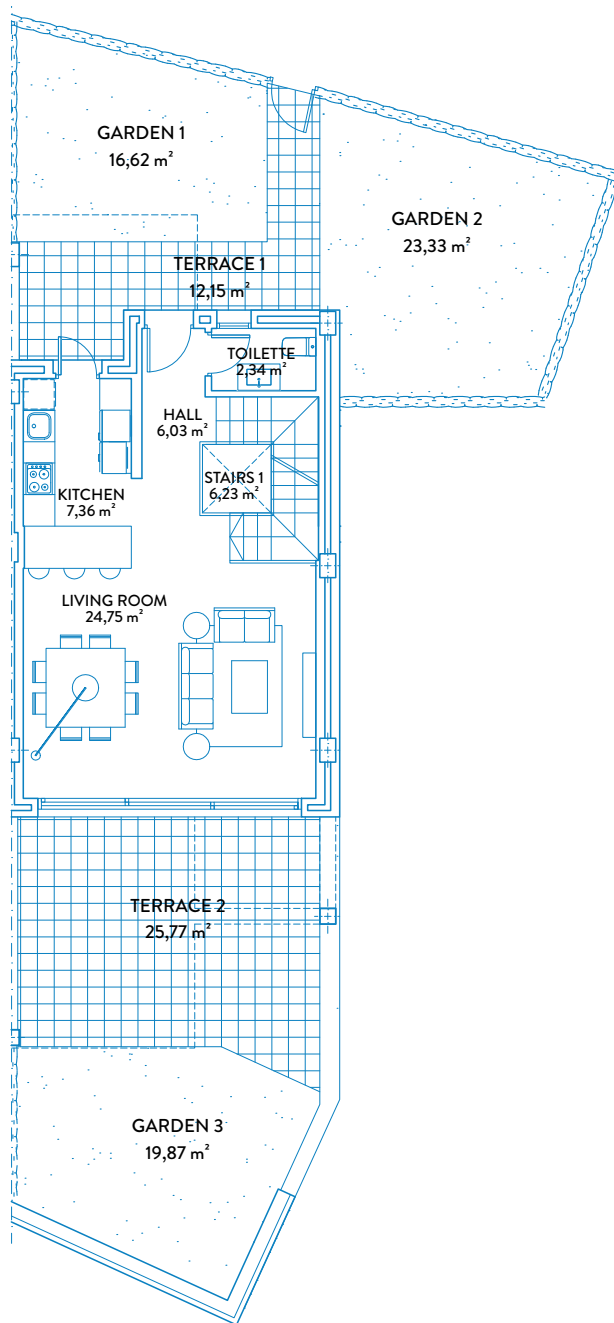

GROUND FLOOR

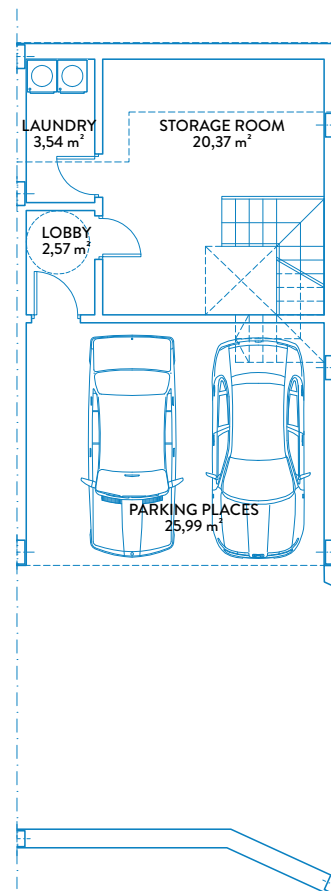

BASEMENT



ESCALA GRÁFICA

BUILT AREAS

Townhouse area	144,89 m ²
Basement area	59,40 m ²
Solarium area	46,35 m ²
Terrace area	47,84 m ²
Garden area	59,82 m ²

USEFUL AREAS

Townhouse area	112,81 m ²
Basement area	52,47 m ²

BOJA AREAS

Useful area	124,09 m ²
Built area	159,38 m ²

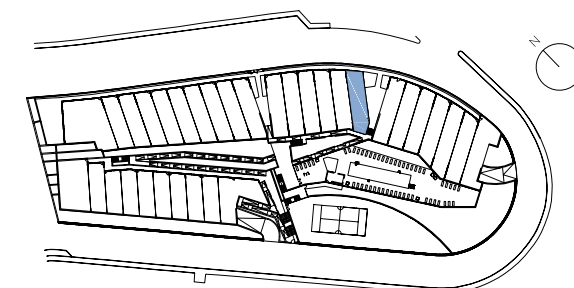

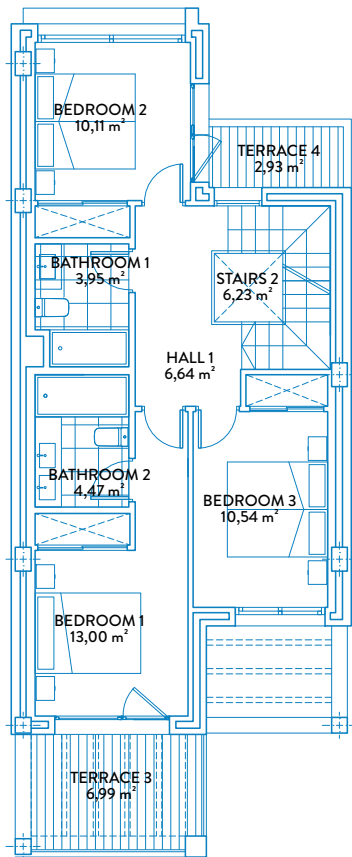

FIRST FLOOR

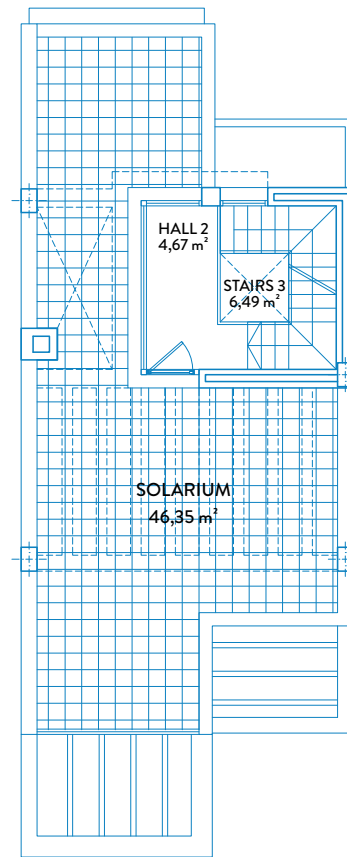

SOLARIUM



BUILT AREAS

Townhouse area	144,89 m ²
Basement area	59,40 m ²
Solarium area	46,35 m ²
Terrace area	47,84 m ²
Garden area	59,82 m ²

USEFUL AREAS

	112,81 m ²
Townhouse area	52,47 m ²
Basement area	

BOJA AREAS

	124,09 m ²
Useful area	159,38 m ²
Built area	

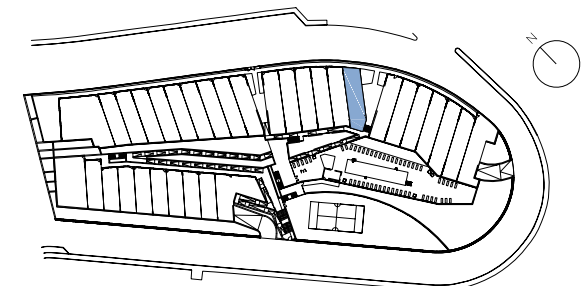

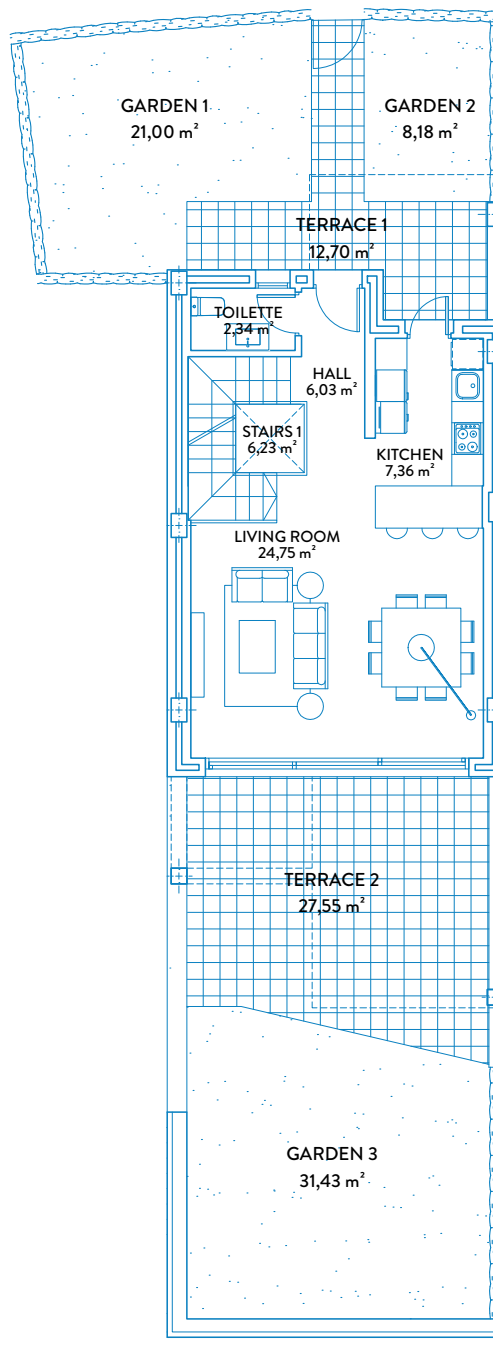

GROUND FLOOR

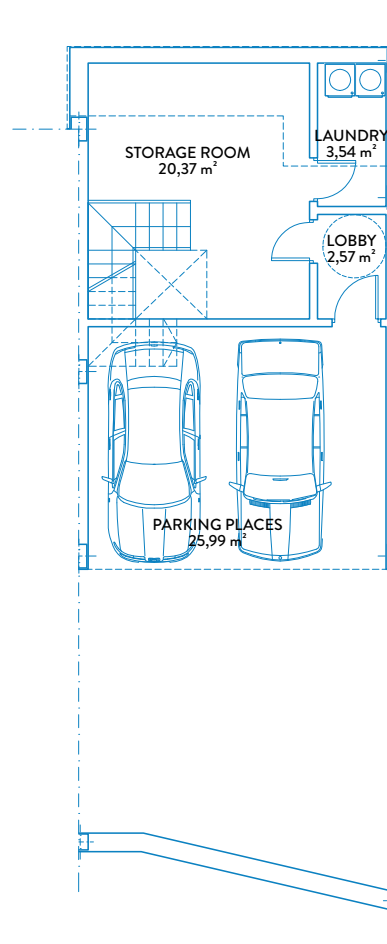

BASEMENT



TOWNHOUSE 17
 TIPE A1
 GROUND FLOOR & BASEMENT



BUILT AREAS

Townhouse area	144,89 m ²
Basement area	59,40 m ²
Solarium area	46,35 m ²
Terrace area	50,17 m ²
Garden area	60,61 m ²

USEFUL AREAS

Townhouse area	112,81 m ²
Basement area	52,47 m ²

BOJA AREAS

Useful area	124,09 m ²
Built area	159,38 m ²

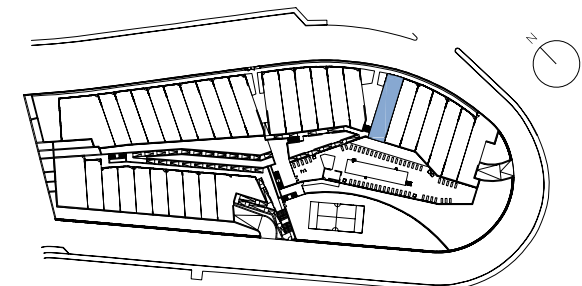

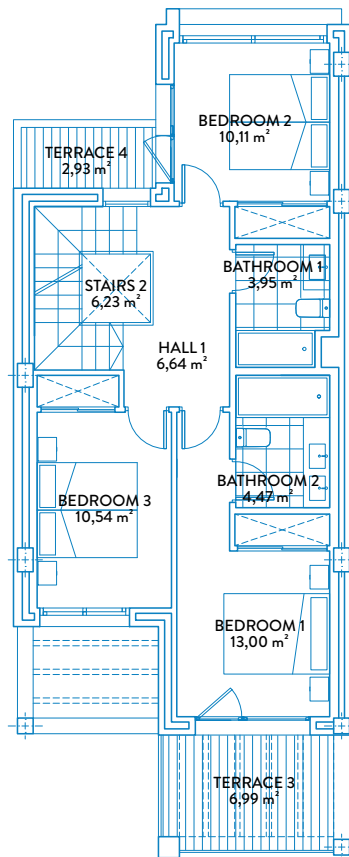

FIRST FLOOR

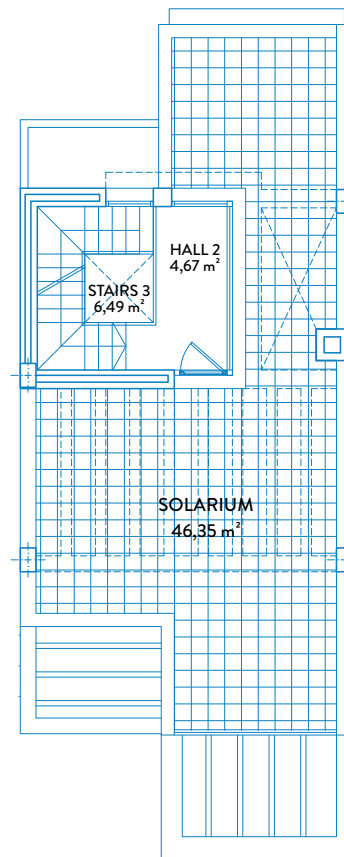

SOLARIUM



BUILT AREAS

Townhouse area	144,89 m ²
Basement area	59,40 m ²
Solarium area	46,35 m ²
Terrace area	50,17 m ²
Garden area	60,61 m ²

USEFUL AREAS

Townhouse area	112,81 m ²
Basement area	52,47 m ²

BOJA AREAS

Useful area	124,09 m ²
Built area	159,38 m ²

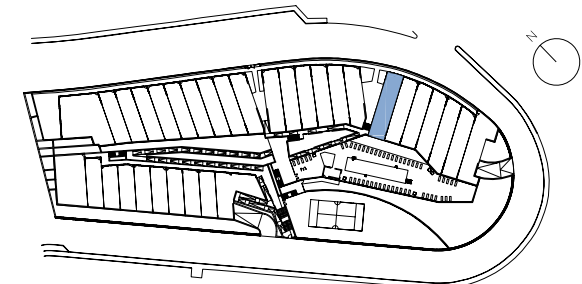

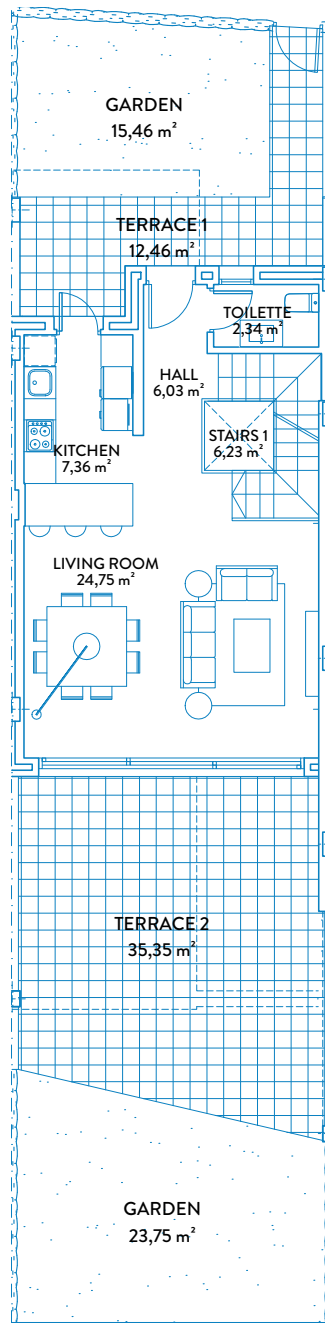

GROUND FLOOR

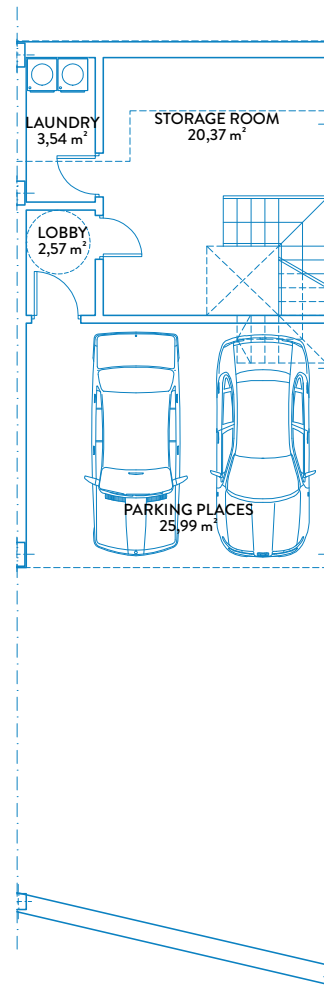

BASEMENT

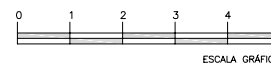

ESCALA GRÁFICA

BUILT AREAS

Townhouse area	139,34 m ²
Basement area	59,40 m ²
Solarium area	46,35 m ²
Terrace area	57,73 m ²
Garden area	39,21 m ²

USEFUL AREAS

Townhouse area	112,81 m ²
Basement area	52,47 m ²

BOJA AREAS

Useful area	124,09 m ²
Built area	153,27 m ²

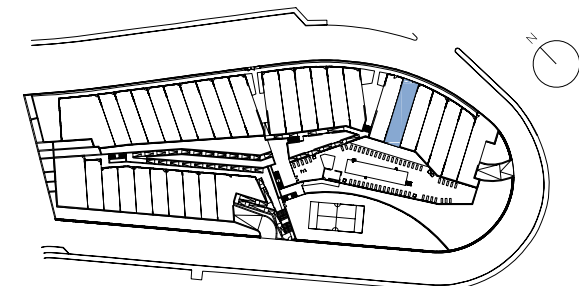

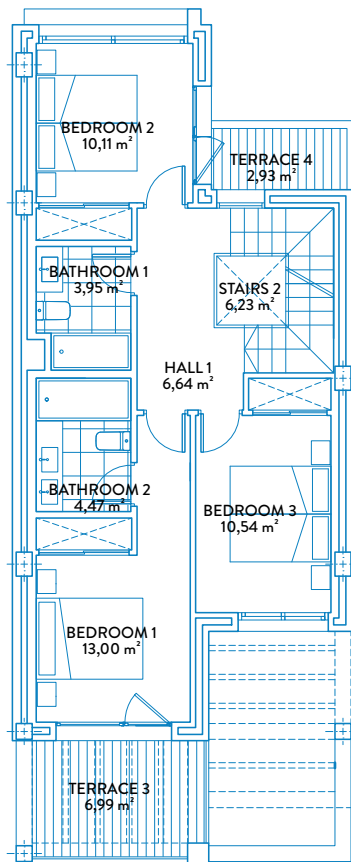

FIRST FLOOR

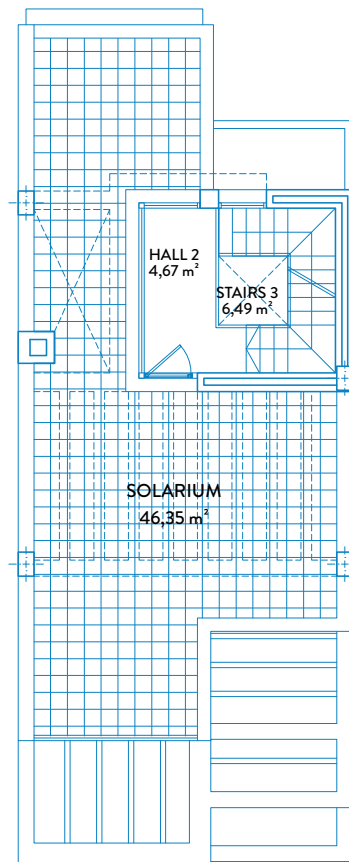

SOLARIUM



BUILT AREAS

Townhouse area	139,34 m ²
Basement area	59,40 m ²
Solarium area	46,35 m ²
Terrace area	57,73 m ²
Garden area	39,21 m ²

USEFUL AREAS

Townhouse area	112,81 m ²
Basement area	52,47 m ²

BOJA AREAS

Useful area	124,09 m ²
Built area	153,27 m ²

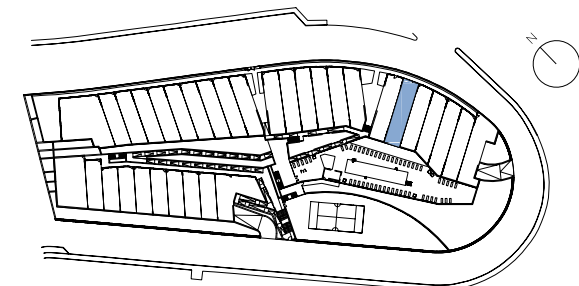

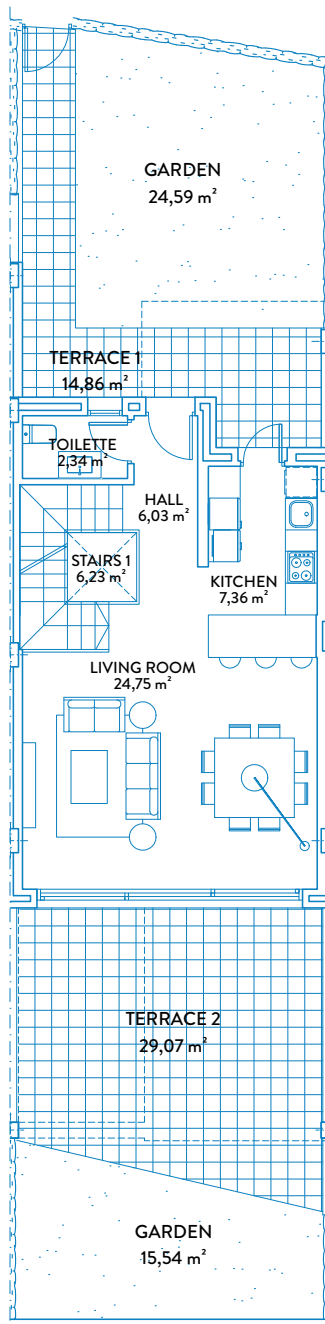

GROUND FLOOR

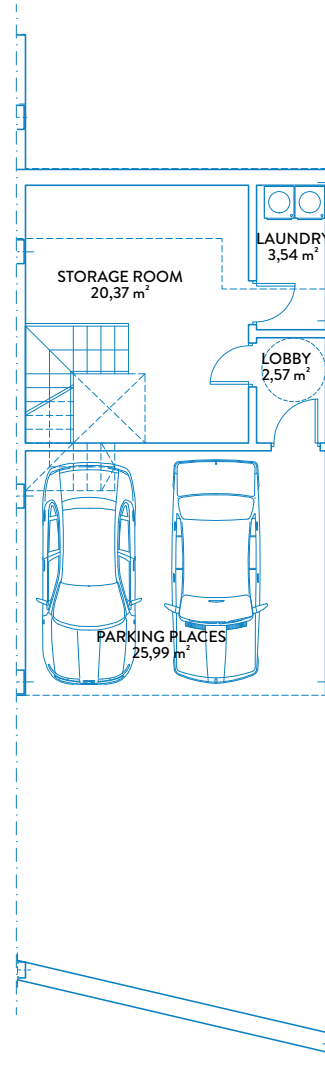

BASEMENT



BUILT AREAS

Townhouse area	139,34 m ²
Basement area	59,40 m ²
Solarium area	46,35 m ²
Terrace area	53,85 m ²
Garden area	40,13 m ²

USEFUL AREAS

Townhouse area	112,81 m ²
Basement area	52,47 m ²

BOJA AREAS

Useful area	124,09 m ²
Built area	153,27 m ²

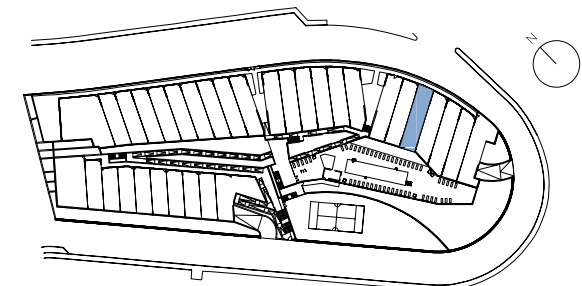

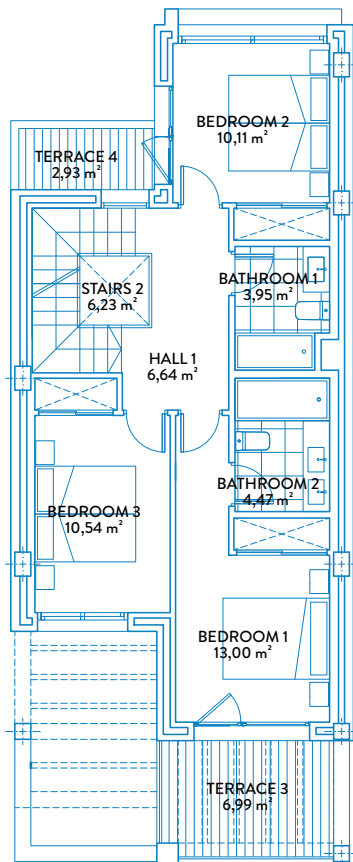

FIRST FLOOR

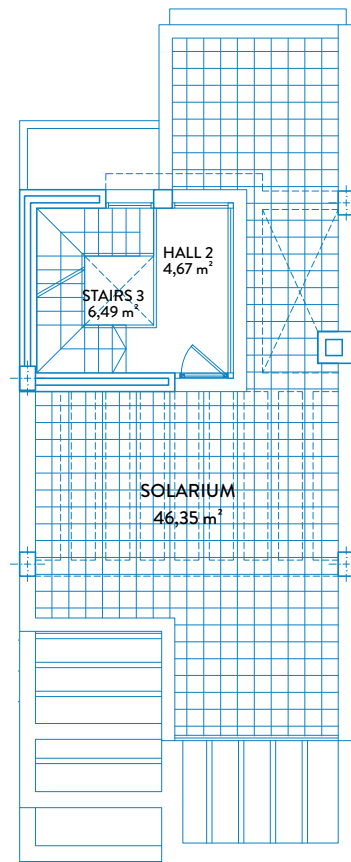

SOLARIUM



BUILT AREAS

Townhouse area	139,34 m ²
Basement area	59,40 m ²
Solarium area	46,35 m ²
Terrace area	53,85 m ²
Garden area	40,13 m ²

USEFUL AREAS

Townhouse area	112,81 m ²
Basement area	52,47 m ²

BOJA AREAS

Useful area	124,09 m ²
Built area	153,27 m ²

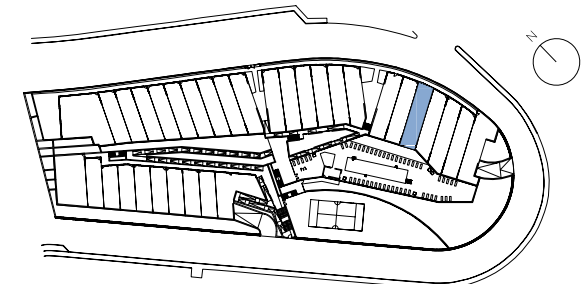

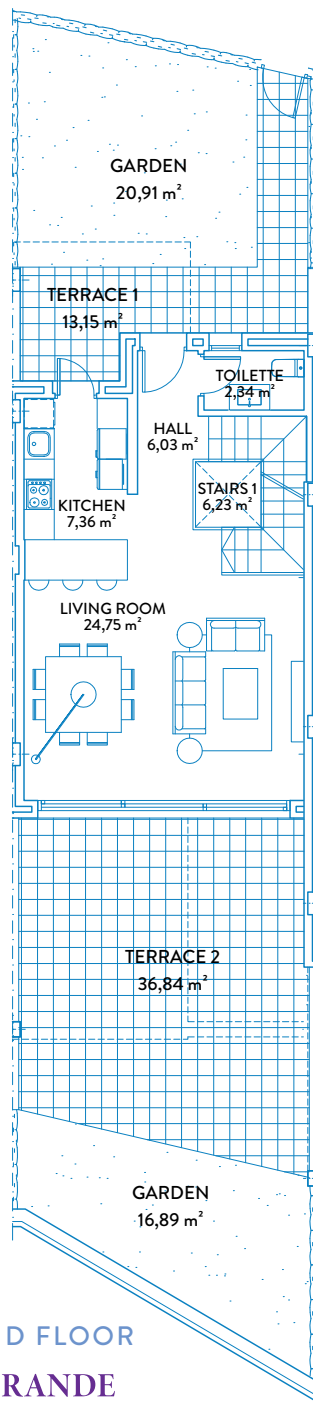

GROUND FLOOR

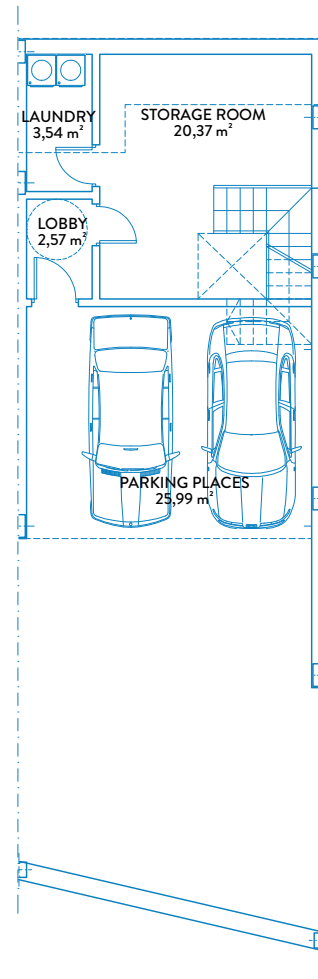

BASEMENT



TOWNHOUSE 20
 TIPE A
 GROUND FLOOR & BASEMENT



BUILT AREAS

Townhouse area	139,34 m ²
Basement area	59,40 m ²
Solarium area	46,35 m ²
Terrace area	59,91 m ²
Garden area	37,80 m ²

USEFUL AREAS

Townhouse area	112,81 m ²
Basement area	52,47 m ²

BOJA AREAS

Useful area	124,09 m ²
Built area	153,27 m ²

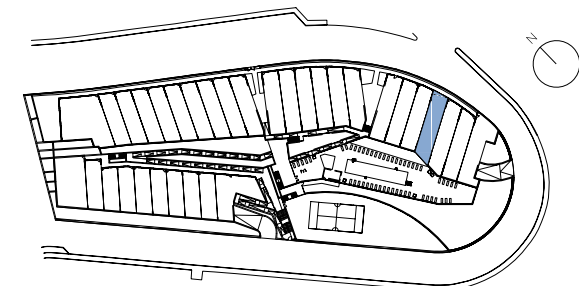

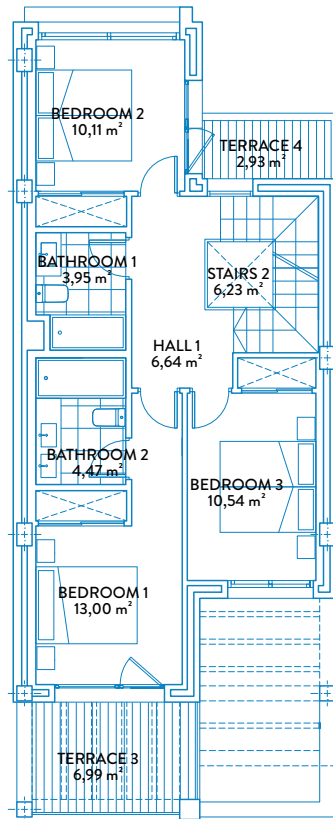

FIRST FLOOR

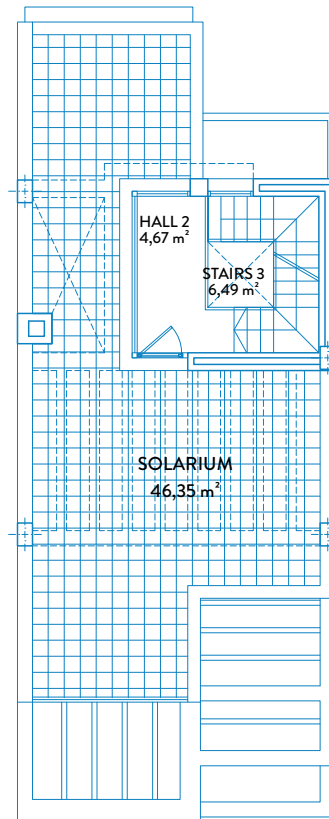

SOLARIUM



BUILT AREAS

Townhouse area	139,34 m ²
Basement area	59,40 m ²
Solarium area	46,35 m ²
Terrace area	59,91 m ²
Garden area	37,80 m ²

USEFUL AREAS

Townhouse area	112,81 m ²
Basement area	52,47 m ²

BOJA AREAS

Useful area	124,09 m ²
Built area	153,27 m ²

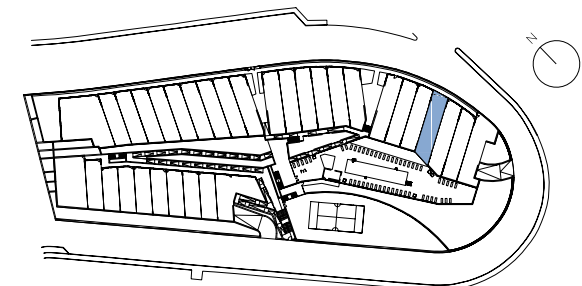

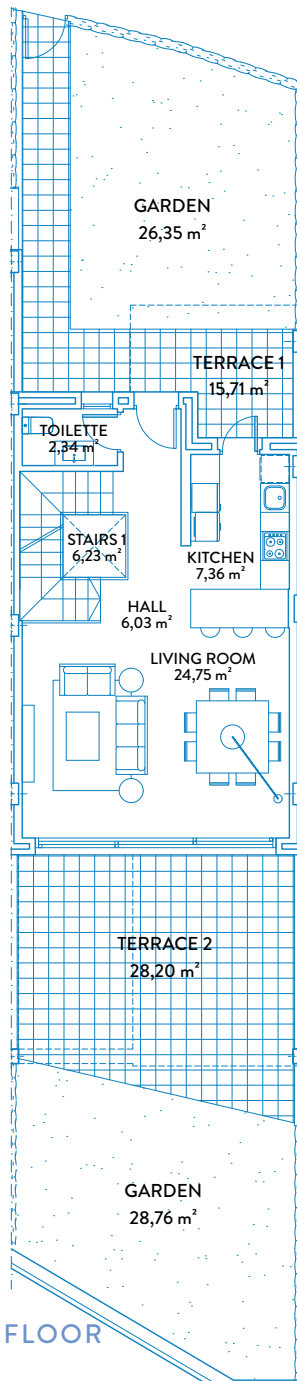

GROUND FLOOR

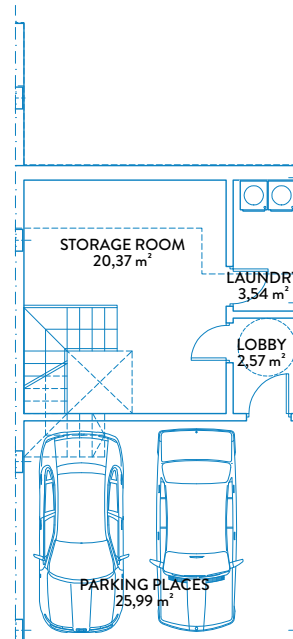

BASEMENT



BUILT AREAS

Townhouse area	139,34 m ²
Basement area	59,40 m ²
Solarium area	46,35 m ²
Terrace area	53,83 m ²
Garden area	55,11 m ²

USEFUL AREAS

Townhouse area	112,81 m ²
Basement area	52,47 m ²

BOJA AREAS

Useful area	124,09 m ²
Built area	153,27 m ²

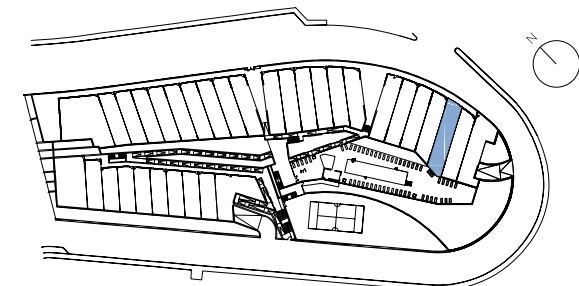

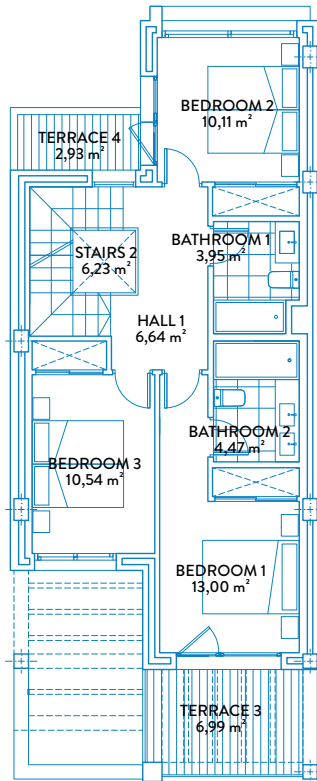

FIRST FLOOR

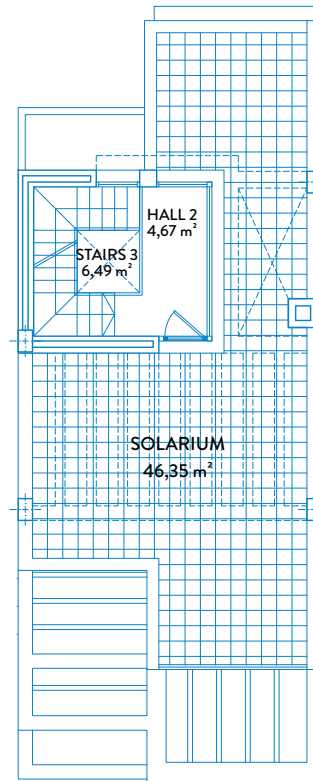

SOLARIUM



BUILT AREAS

Townhouse area	139,34 m ²
Basement area	59,40 m ²
Solarium area	46,35 m ²
Terrace area	53,83 m ²
Garden area	55,11 m ²

USEFUL AREAS

Townhouse area	112,81 m ²
Basement area	52,47 m ²

BOJA AREAS

Useful area	124,09 m ²
Built area	153,27 m ²

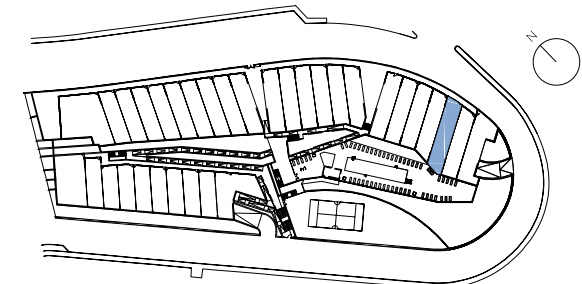

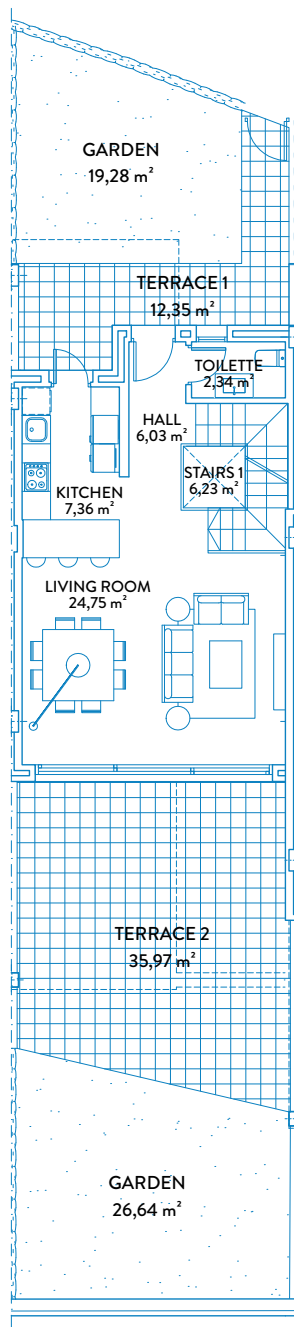

GROUND FLOOR

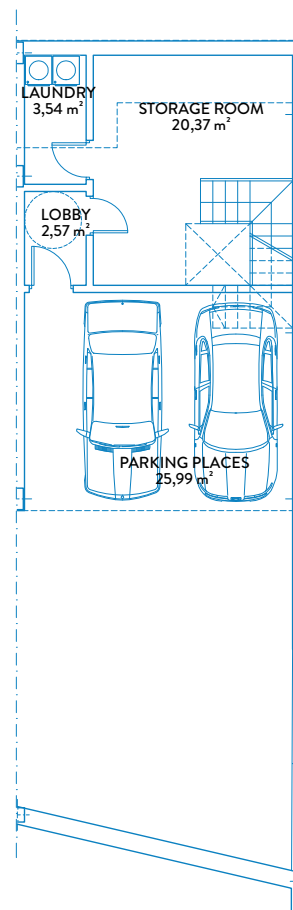

BASEMENT



TOWNHOUSE 22
 TIPE A
 GROUND FLOOR & BASEMENT



BUILT AREAS

Townhouse area	139,34 m ²
Basement area	59,40 m ²
Solarium area	46,35 m ²
Terrace area	58,24 m ²
Garden area	45,92 m ²

USEFUL AREAS

Townhouse area	112,81 m ²
Basement area	52,47 m ²

BOJA AREAS

Useful area	124,09 m ²
Built area	153,27 m ²

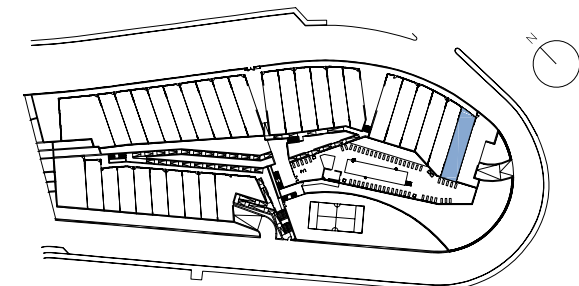

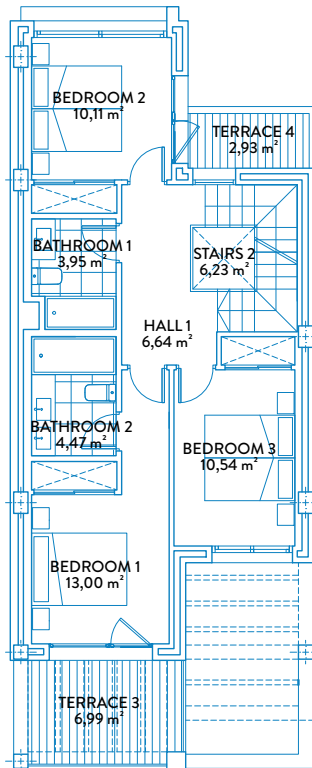

FIRST FLOOR

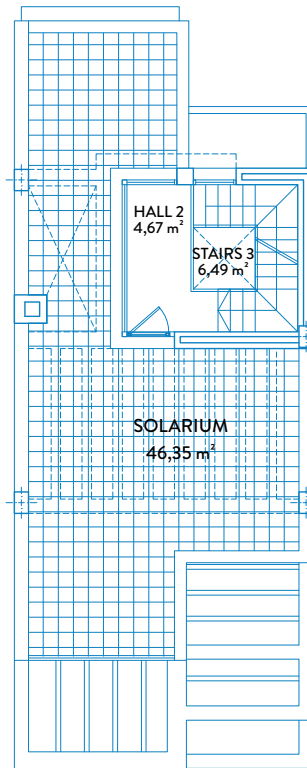

SOLARIUM



BUILT AREAS

Townhouse area	139,34 m ²
Basement area	59,40 m ²
Solarium area	46,35 m ²
Terrace area	58,24 m ²
Garden area	45,92 m ²

USEFUL AREAS

Townhouse area	112,81 m ²
Basement area	52,47 m ²

BOJA AREAS

Useful area	124,09 m ²
Built area	153,27 m ²

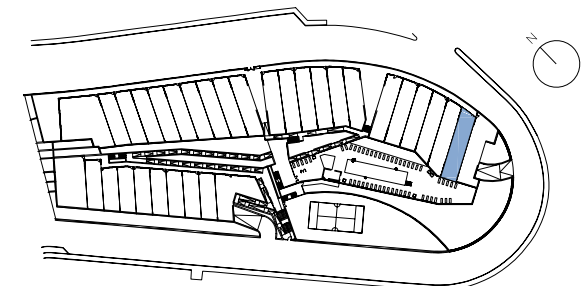

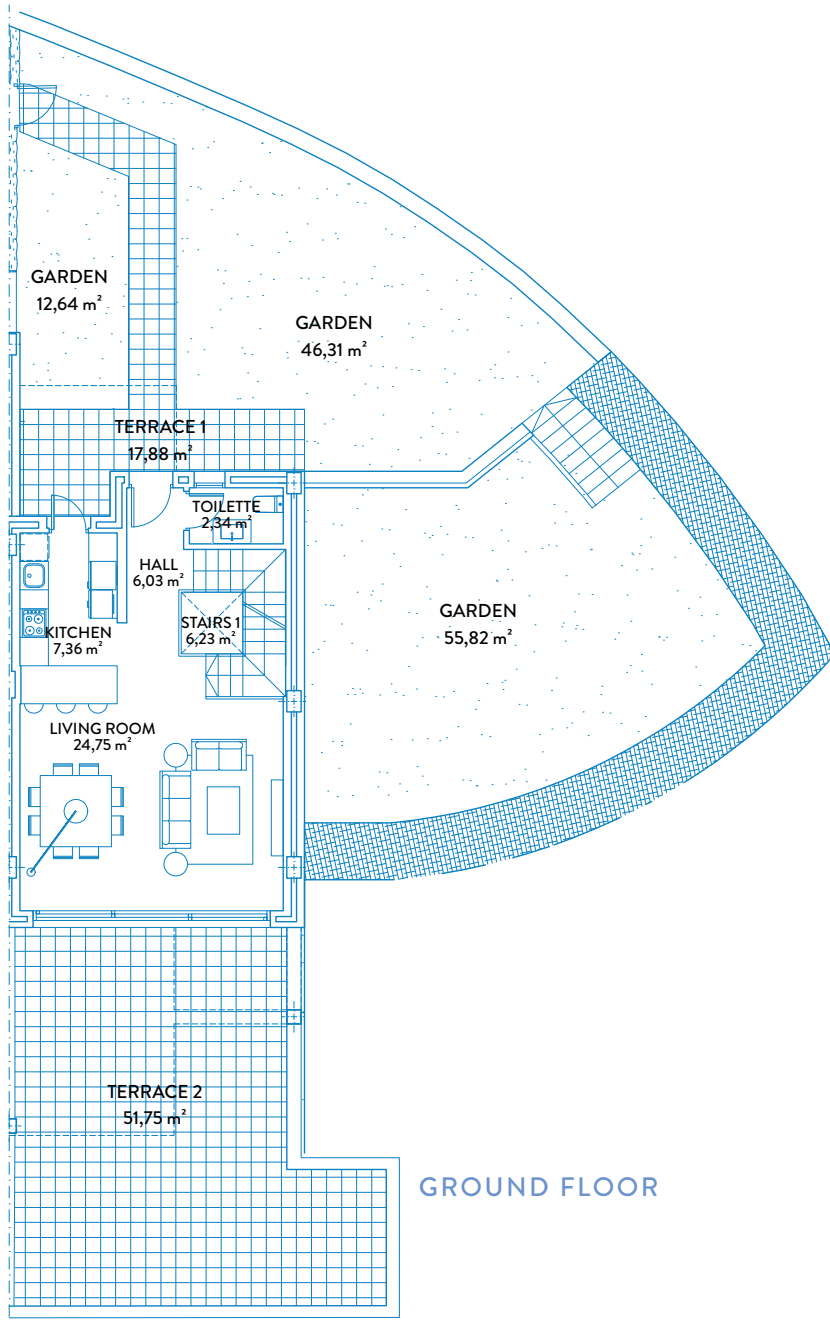

GROUND FLOOR

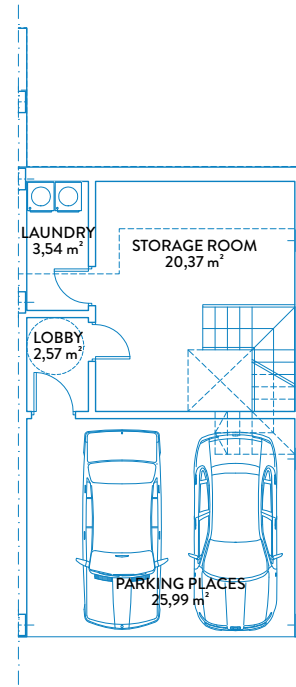

BASEMENT

BUILT AREAS

Townhouse area	144,89 m ²
Basement area	59,40 m ²
Solarium area	46,35 m ²
Terrace area	79,55 m ²
Garden area	114,77 m ²

USEFUL AREAS

Townhouse area	112,81 m ²
Basement area	52,47 m ²

BOJA AREAS

Useful area	124,09 m ²
Built area	159,38 m ²

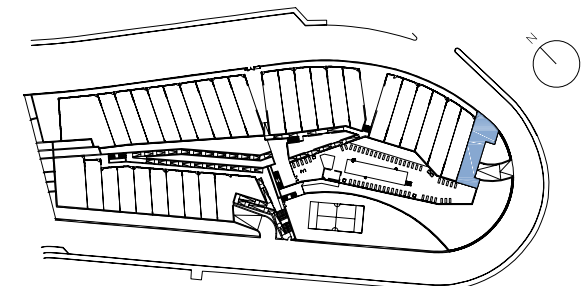
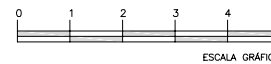

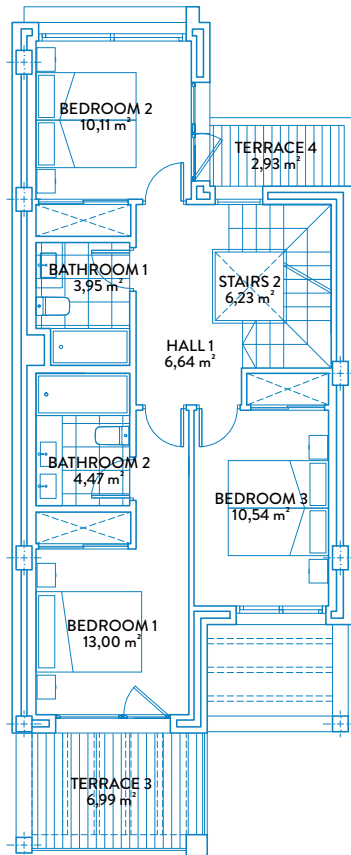

FIRST FLOOR

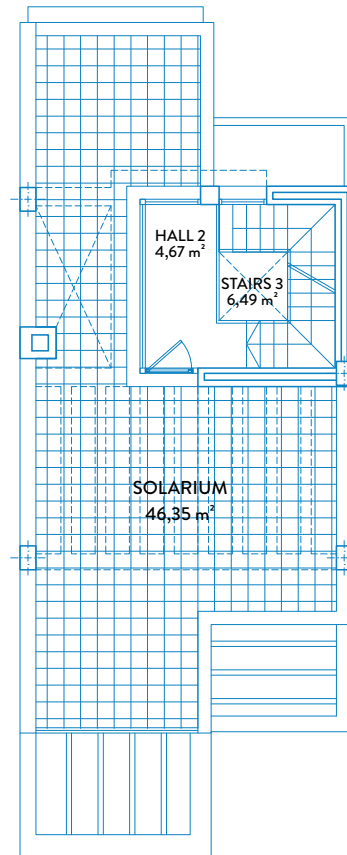

SOLARIUM



BUILT AREAS

Townhouse area	144,89 m ²
Basement area	59,40 m ²
Solarium area	46,35 m ²
Terrace area	79,55 m ²
Garden area	114,77 m ²

USEFUL AREAS

Townhouse area	112,81 m ²
Basement area	52,47 m ²

BOJA AREAS

Useful area	124,09 m ²
Built area	159,38 m ²

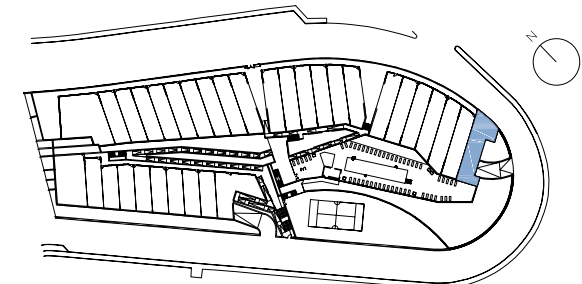

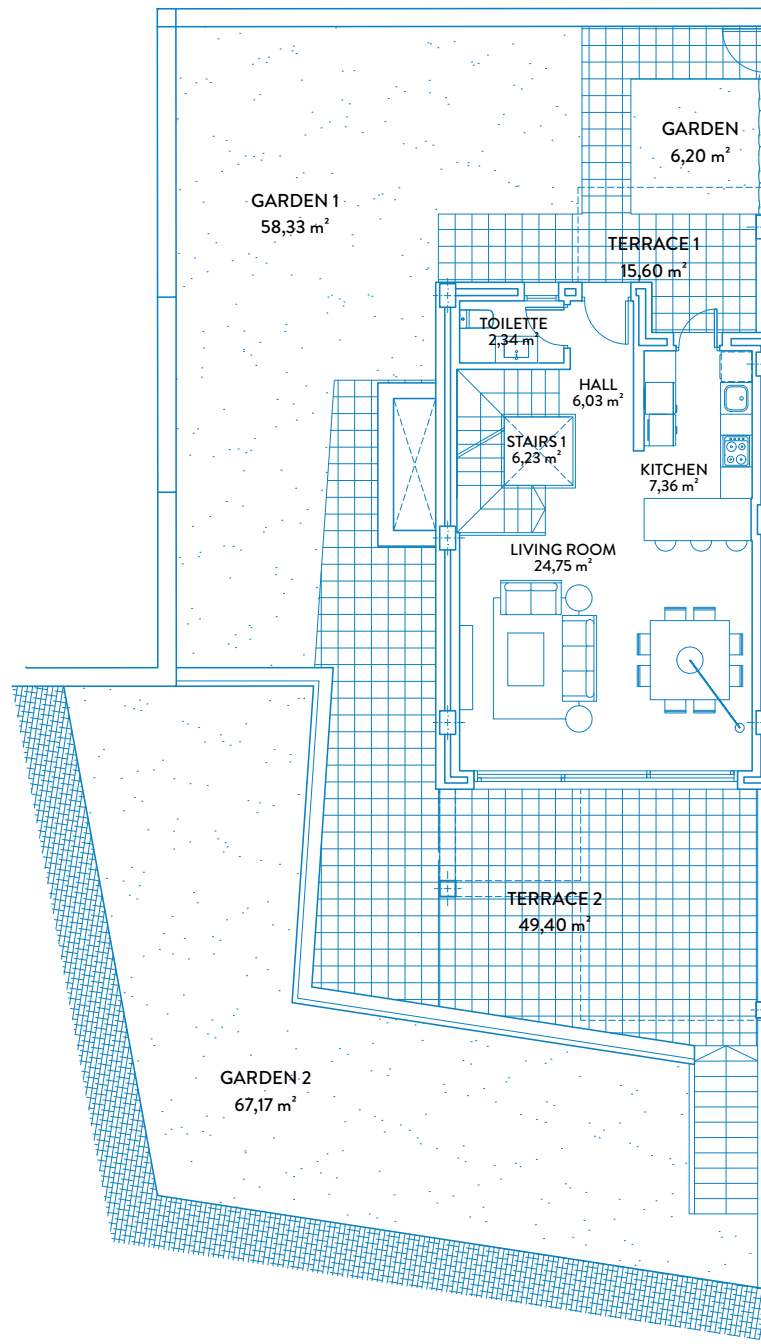

GROUND FLOOR

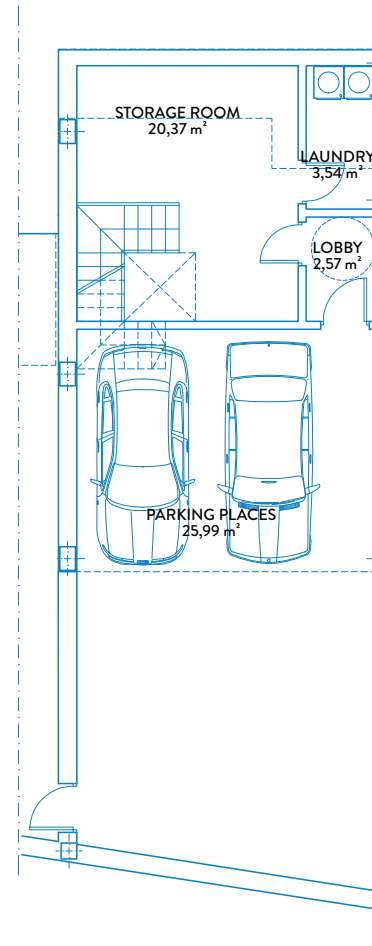

BASEMENT

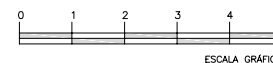

BUILT AREAS

Townhouse area	144,89 m ²
Basement area	59,40 m ²
Solarium area	46,35 m ²
Terrace area	74,92 m ²
Garden area	131,70 m ²

USEFUL AREAS

Townhouse area	112,81 m ²
Basement area	52,47 m ²

BOJA AREAS

Useful area	124,09 m ²
Built area	159,38 m ²

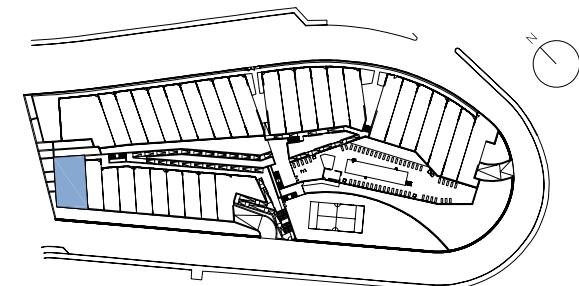

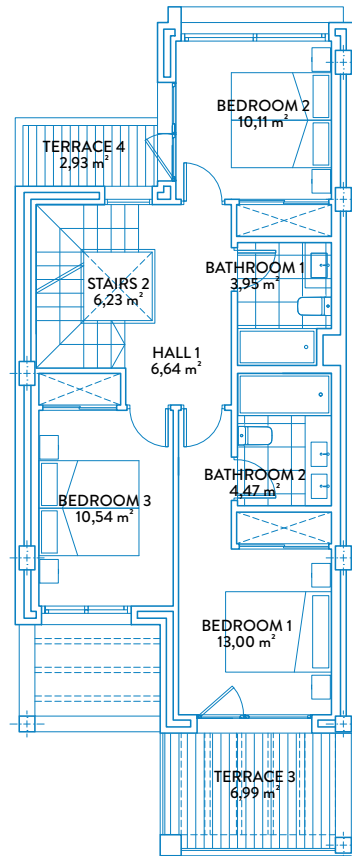

FIRST FLOOR

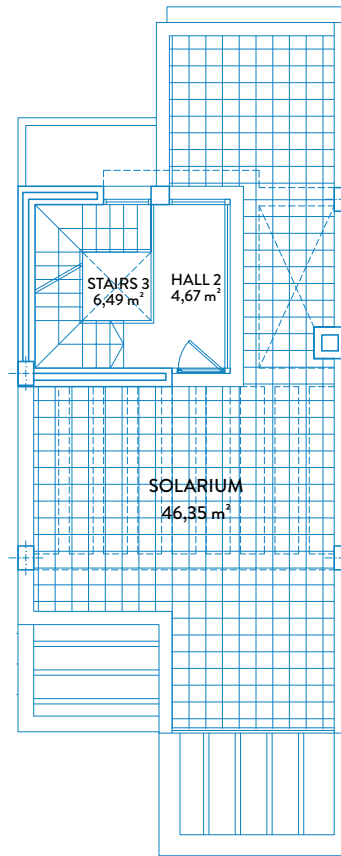

SOLARIUM



BUILT AREAS

Townhouse area	144,89 m ²
Basement area	59,40 m ²
Solarium area	46,35 m ²
Terrace area	74,92 m ²
Garden area	131,70 m ²

USEFUL AREAS

Townhouse area	112,81 m ²
Basement area	52,47 m ²

BOJA AREAS

Useful area	124,09 m ²
Built area	159,38 m ²

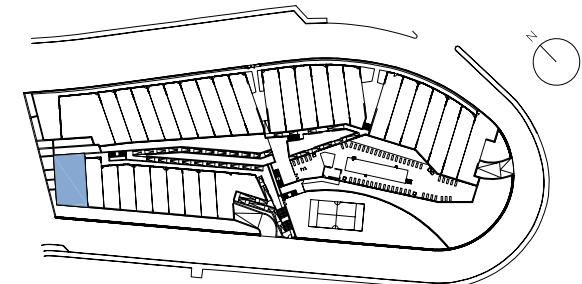

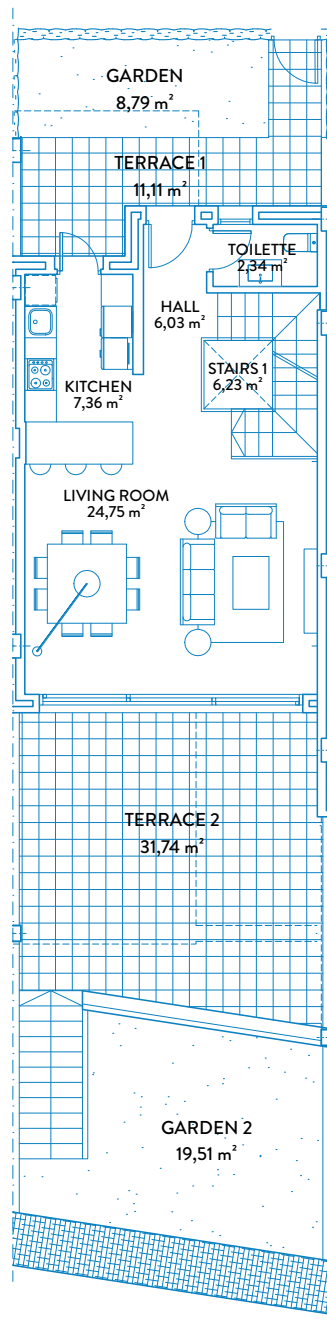

GROUND FLOOR

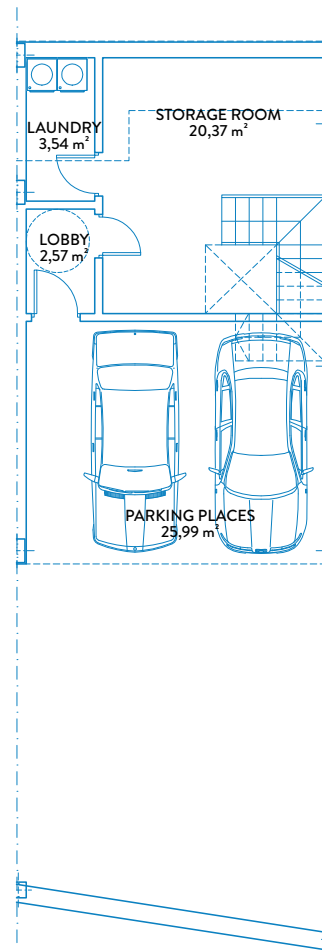

BASEMENT

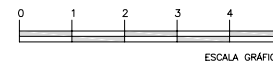

ESCALA GRAFICA

BUILT AREAS

Townhouse area	139,34 m ²
Basement area	59,40 m ²
Solarium area	46,35 m ²
Terrace area	52,77 m ²
Garden area	28,30 m ²

USEFUL AREAS

Townhouse area	112,81 m ²
Basement area	52,47 m ²

BOJA AREAS

Useful area	124,09 m ²
Built area	153,27 m ²

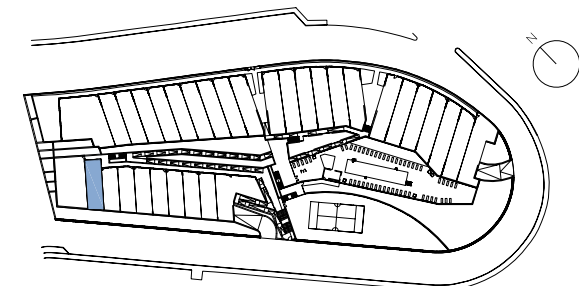

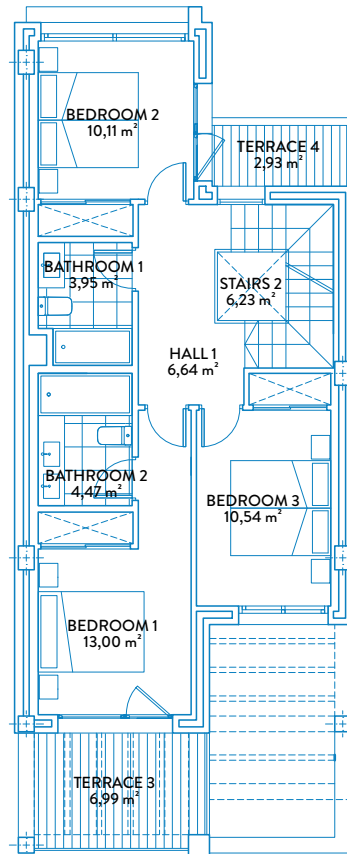

FIRST FLOOR

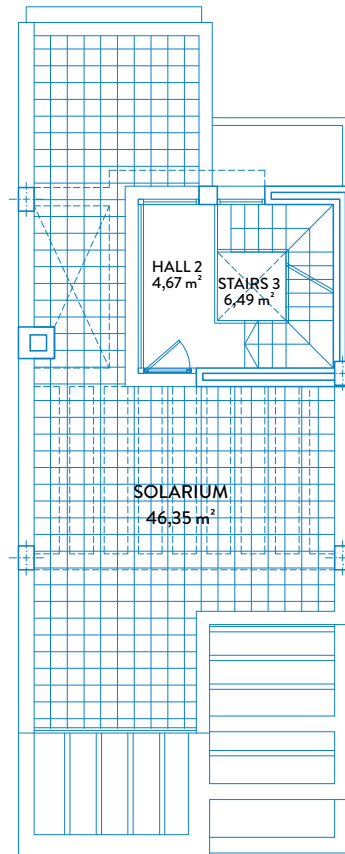

SOLARIUM



BUILT AREAS

Townhouse area	139,34 m ²
Basement area	59,40 m ²
Solarium area	46,35 m ²
Terrace area	52,77 m ²
Garden area	28,30 m ²

USEFUL AREAS

Townhouse area	112,81 m ²
Basement area	52,47 m ²

BOJA AREAS

Useful area	124,09 m ²
Built area	153,27 m ²

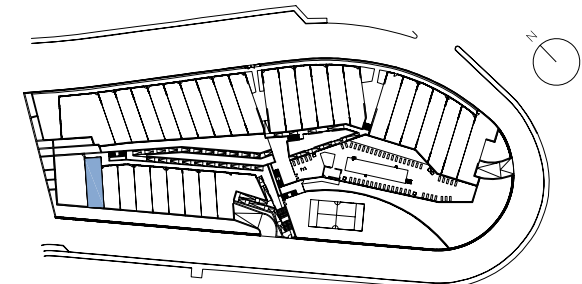

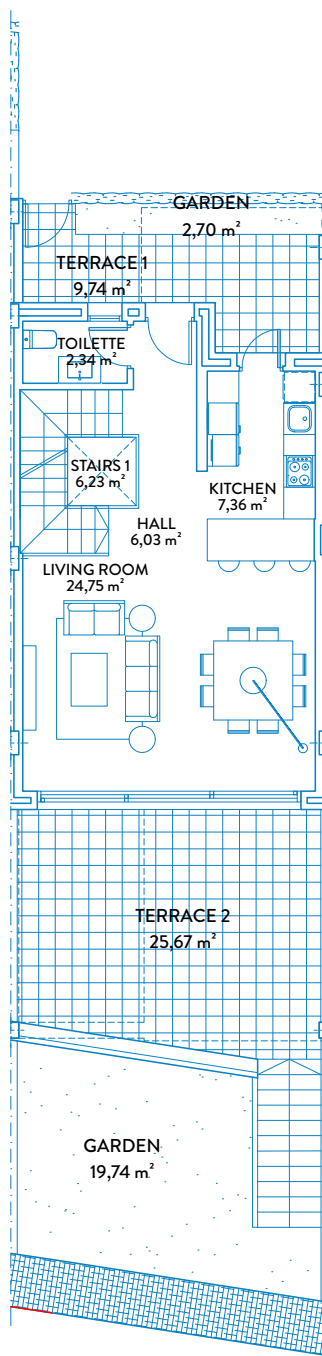

GROUND FLOOR

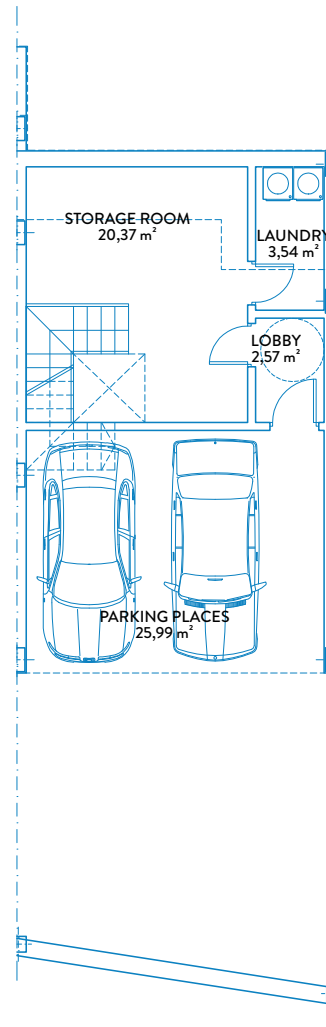

BASEMENT

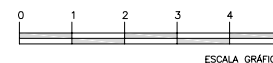

BUILT AREAS

Townhouse area	139,34 m ²
Basement area	59,40 m ²
Solarium area	46,35 m ²
Terrace area	45,33 m ²
Garden area	22,44 m ²

USEFUL AREAS

Townhouse area	112,81 m ²
Basement area	52,47 m ²

BOJA AREAS

Useful area	124,09 m ²
Built area	153,27 m ²

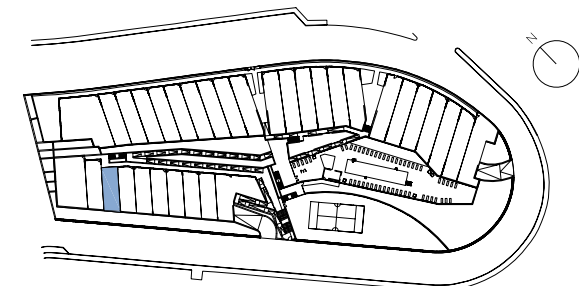

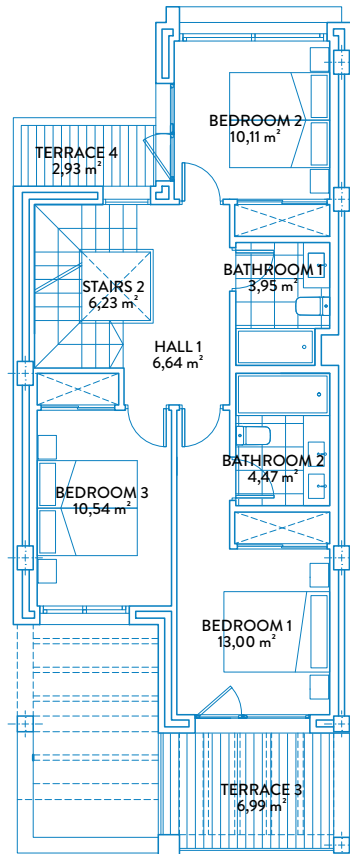

FIRST FLOOR

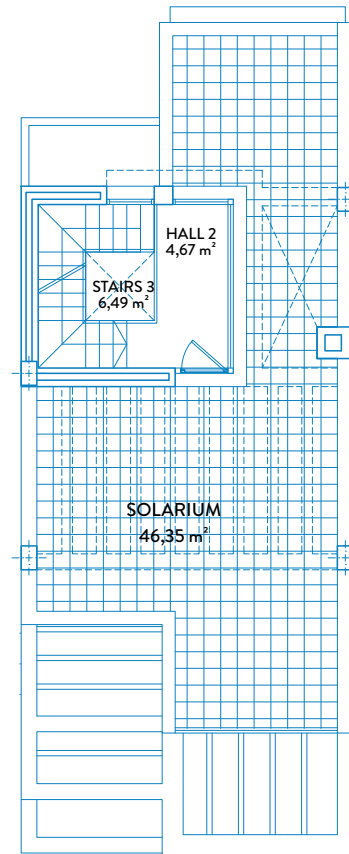

SOLARIUM

BUILT AREAS

Townhouse area	139,34 m ²
Basement area	59,40 m ²
Solarium area	46,35 m ²
Terrace area	45,33 m ²
Garden area	22,44 m ²

USEFUL AREAS

Townhouse area	112,81 m ²
Basement area	52,47 m ²

BOJA AREAS

Useful area	124,09 m ²
Built area	153,27 m ²

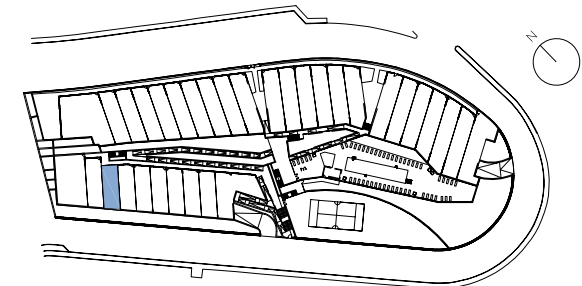

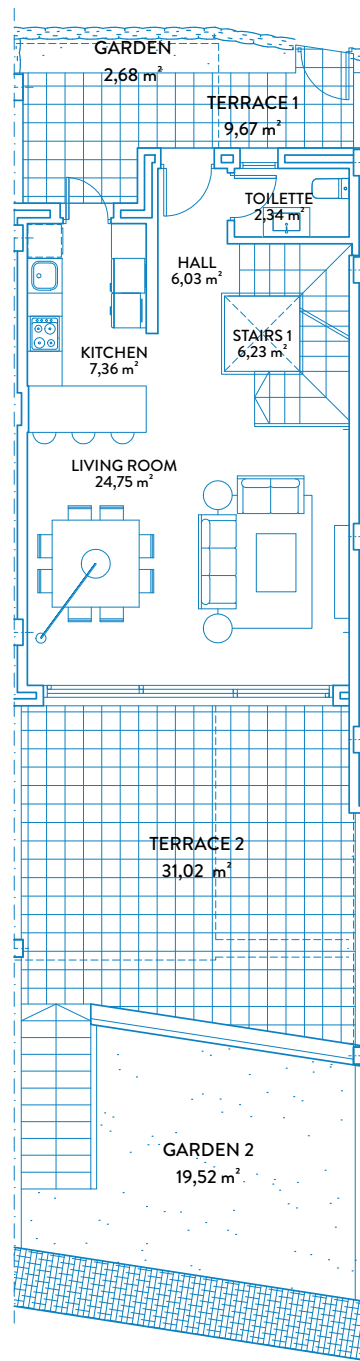

GROUND FLOOR

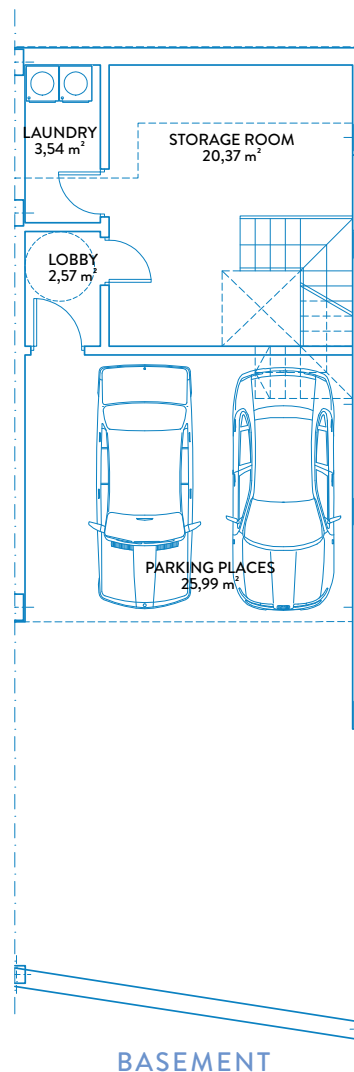

BASEMENT



ESCALA GRÁFICA

TOWNHOUSE 27
 TIPE A
 GROUND FLOOR & BASEMENT



BUILT AREAS

Townhouse area	139,34 m ²
Basement area	59,40 m ²
Solarium area	46,35 m ²
Terrace area	50,61 m ²
Garden area	22,20 m ²

USEFUL AREAS

Townhouse area	112,81 m ²
Basement area	52,47 m ²

BOJA AREAS

Useful area	124,09 m ²
Built area	153,27 m ²

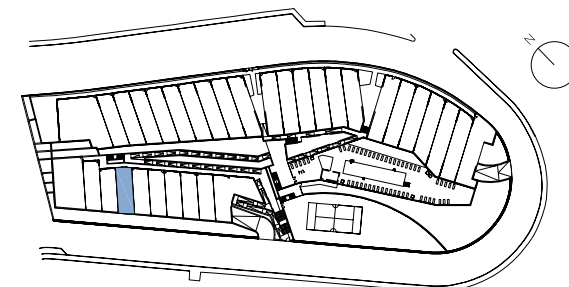

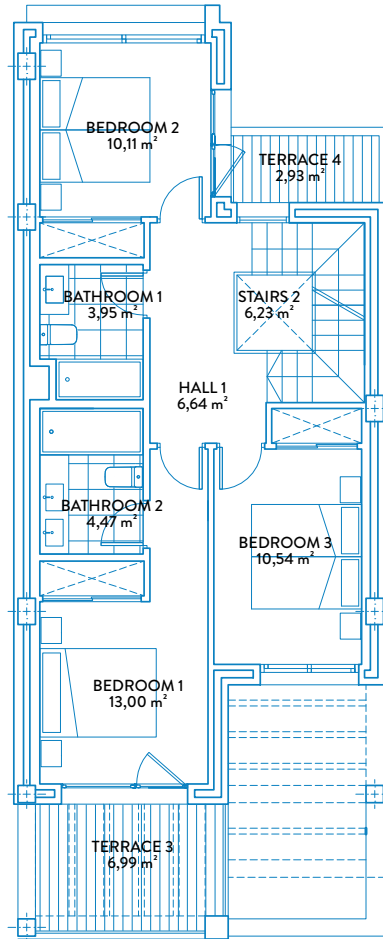

FIRST FLOOR

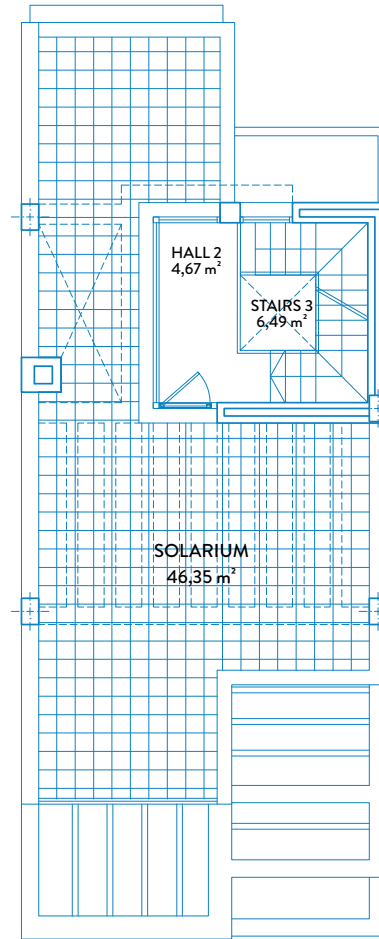

SOLARIUM



BUILT AREAS

Townhouse area	139,34 m ²
Basement area	59,40 m ²
Solarium area	46,35 m ²
Terrace area	50,61 m ²
Garden area	22,20 m ²

USEFUL AREAS

Townhouse area	112,81 m ²
Basement area	52,47 m ²

BOJA AREAS

Useful area	124,09 m ²
Built area	153,27 m ²

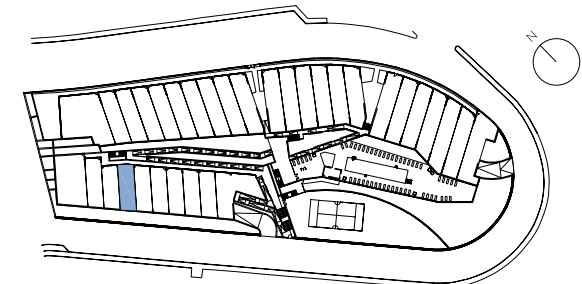

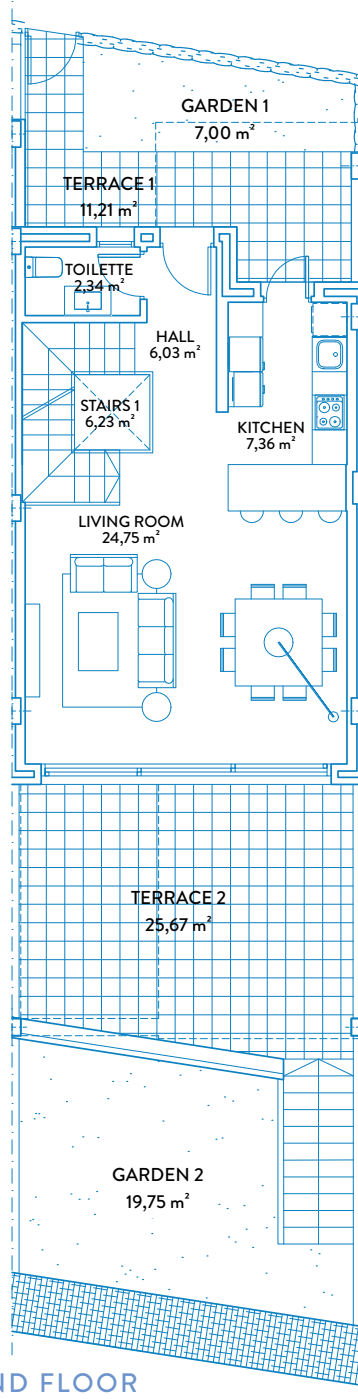

GROUND FLOOR

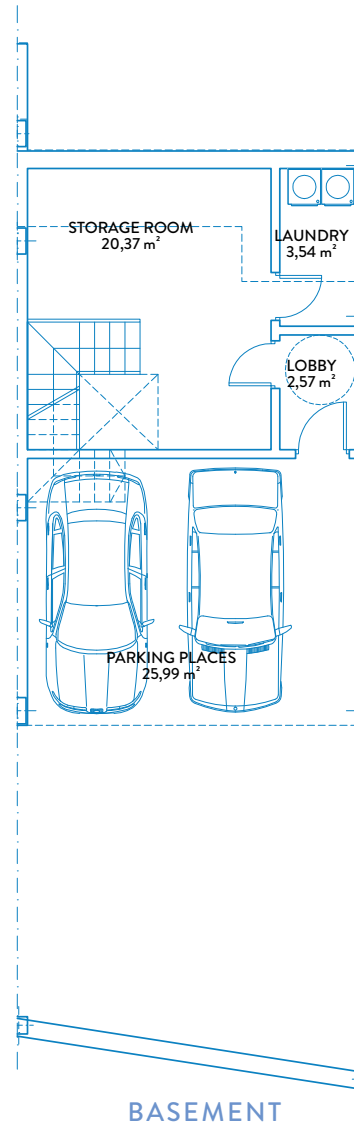

BASEMENT



ESCALA GRÁFICA

BUILT AREAS

Townhouse area	139,34 m ²
Basement area	59,40 m ²
Solarium area	46,35 m ²
Terrace area	46,80 m ²
Garden area	26,75 m ²

USEFUL AREAS

Townhouse area	112,81 m ²
Basement area	52,47 m ²

BOJA AREAS

Useful area	124,09 m ²
Built area	153,27 m ²

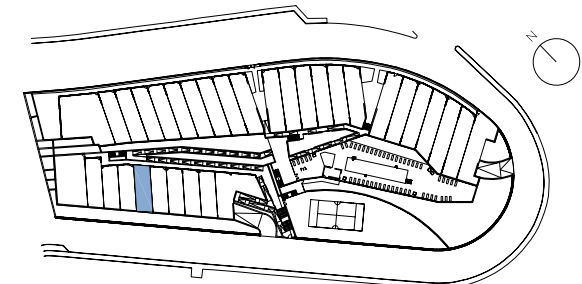

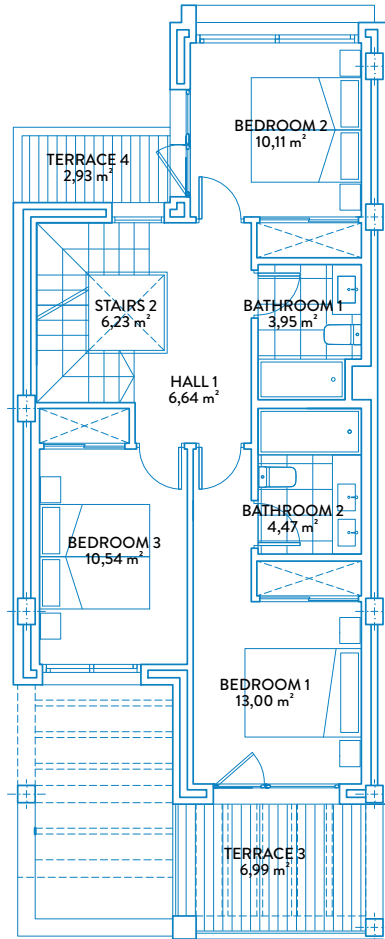

FIRST FLOOR

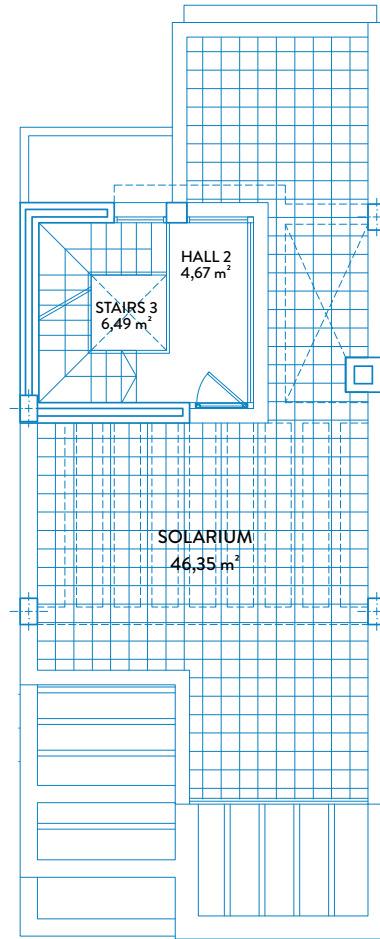

SOLARIUM



BUILT AREAS

Townhouse area	139,34 m ²
Basement area	59,40 m ²
Solarium area	46,35 m ²
Terrace area	46,80 m ²
Garden area	26,75 m ²

USEFUL AREAS

Townhouse area	112,81 m ²
Basement area	52,47 m ²

BOJA AREAS

Useful area	124,09 m ²
Built area	153,27 m ²

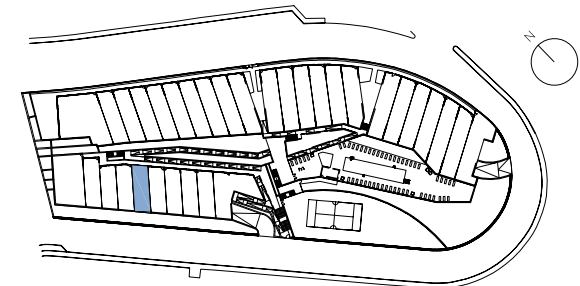

ESCALA GRÁFICA

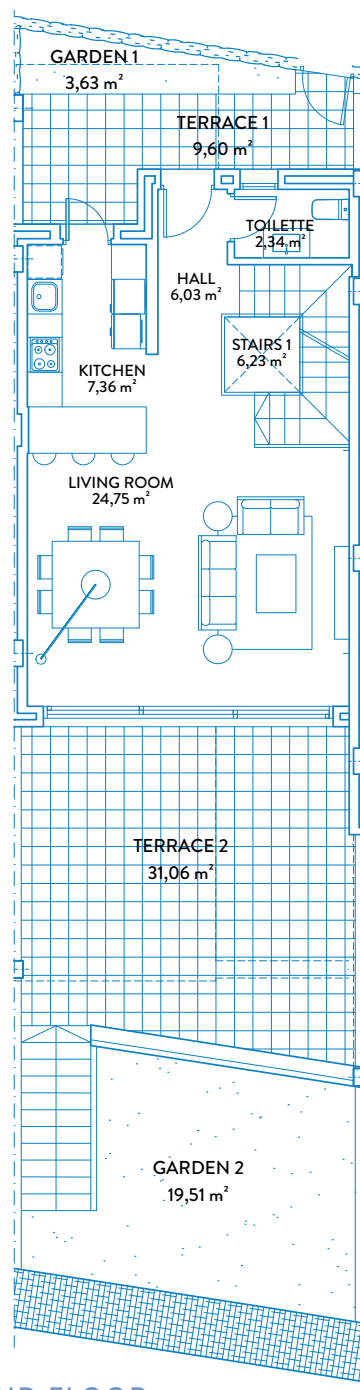

GROUND FLOOR

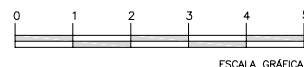
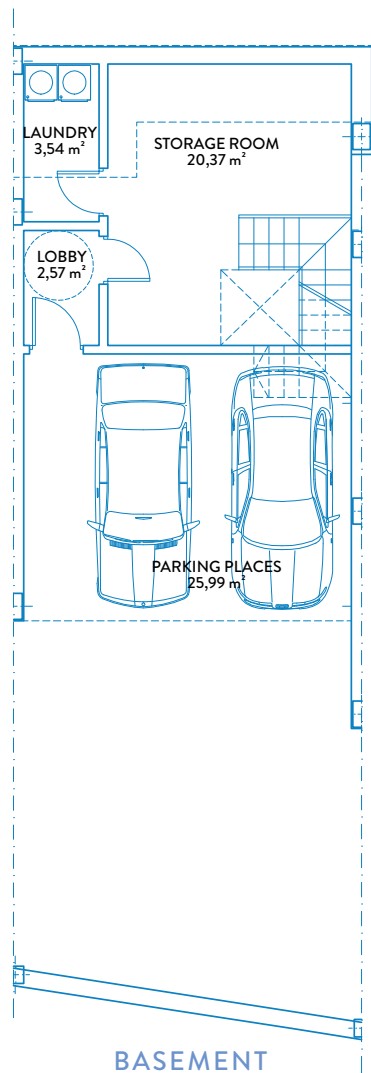

TOWNHOUSE 29

TIPE A

GROUND FLOOR & BASEMENT



BUILT AREAS

Townhouse area	139,34 m ²
Basement area	59,40 m ²
Solarium area	46,35 m ²
Terrace area	50,58 m ²
Garden area	23,14 m ²

USEFUL AREAS

Townhouse area	112,81 m ²
Basement area	52,47 m ²

BOJA AREAS

Useful area	124,09 m ²
Built area	153,27 m ²

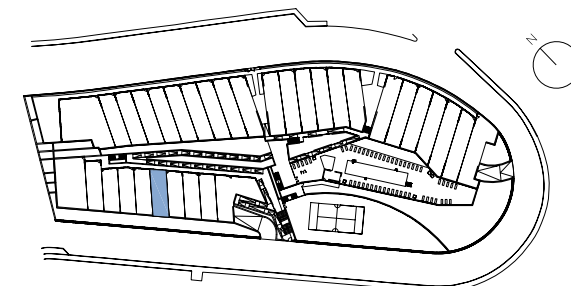

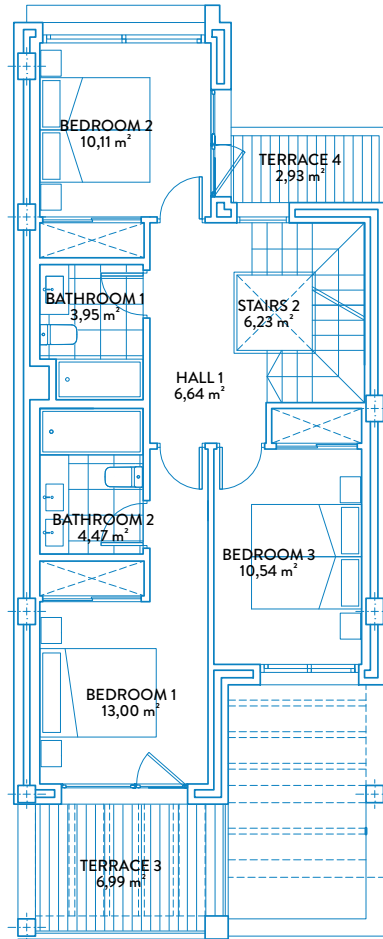

FIRST FLOOR

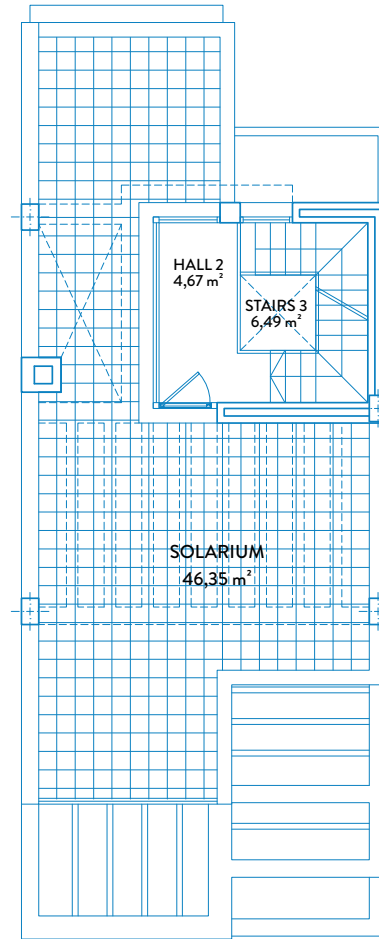

SOLARIUM



BUILT AREAS

Townhouse area	139,34 m ²
Basement area	59,40 m ²
Solarium area	46,35 m ²
Terrace area	50,58 m ²
Garden area	23,14 m ²

USEFUL AREAS

Townhouse area	112,81 m ²
Basement area	52,47 m ²

BOJA AREAS

Useful area	124,09 m ²
Built area	153,27 m ²

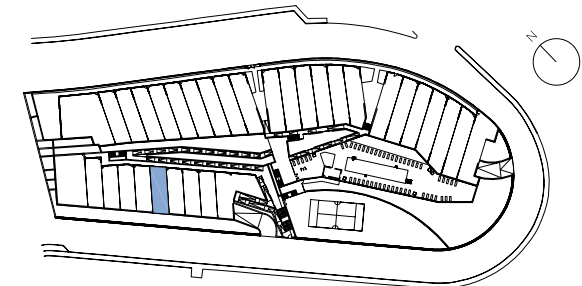

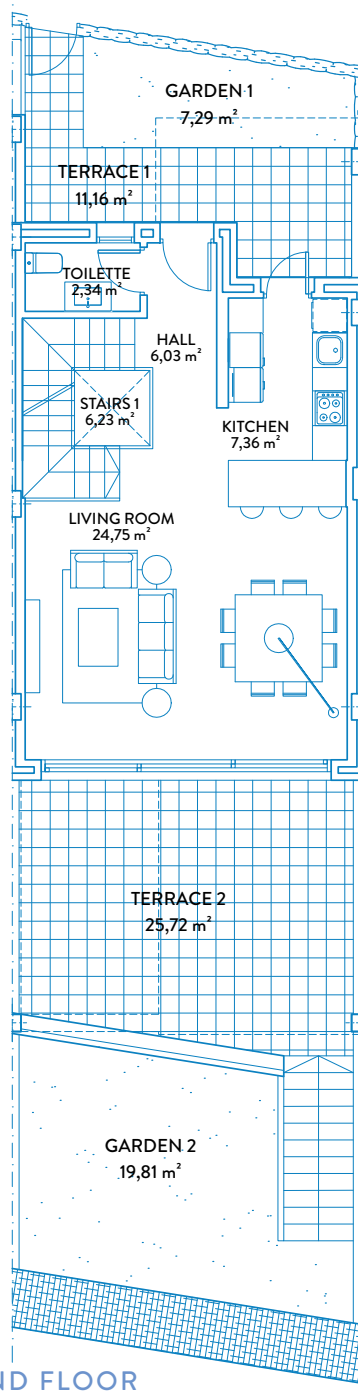

GROUND FLOOR

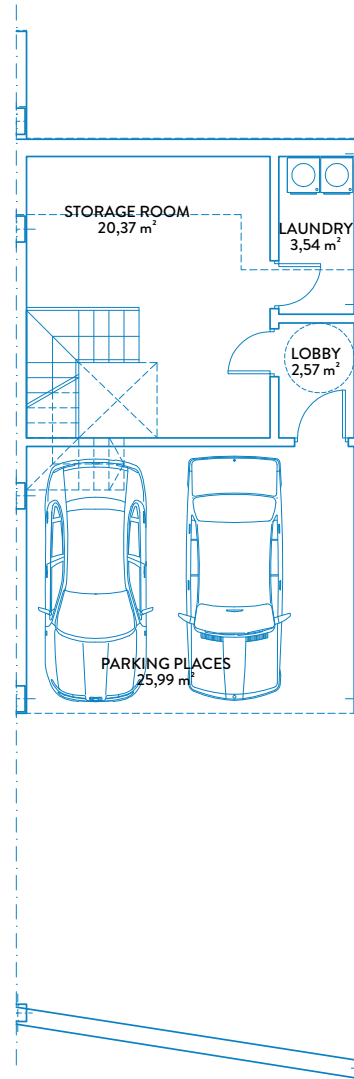

BASEMENT

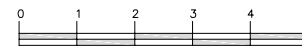

ESCALA GRÁFICA

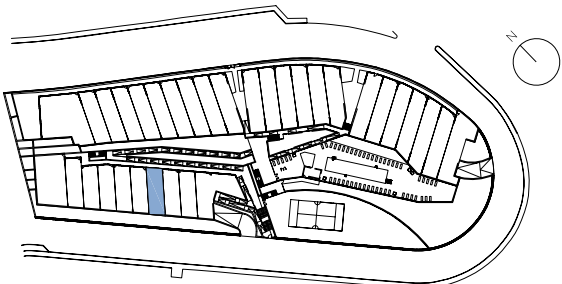

BUILT AREAS

Townhouse area	139,34 m ²
Basement area	59,40 m ²
Solarium area	46,35 m ²
Terrace area	46,80 m ²
Garden area	27,10 m ²

USEFUL AREAS

Townhouse area	112,81 m ²
Basement area	52,47 m ²

BOJA AREAS

Useful area	124,09 m ²
Built area	153,27 m ²



Information and graphic material are purely informative and have no contractual value. They may be subject to changes due to technical or legal requirements or by initiative of the Project Management team. Gardening, decoration and furniture are for the purpose of decoration and are non-binding. The remaining information referring to the Royal Decree 218/2005 from the Andalusian Government is available in our offices.



(+34) 607 911 661 / info@noll-sotogrande.com

www.noll-sotogrande.com